

Serie 50000

 50000N Pag. 1.7	 50010N Pag. 1.7	New  50020N Pag. 1.8	 50030N Pag. 1.8	 50040N Pag. 1.9	New  50050N Pag. 1.9	New  50055N Pag. 1.9	New  50465N Pag. 1.9	 50100N Pag. 1.10
New  50106N Pag. 1.10	 50111N Pag. 1.10	 50116N Pag. 1.11	 50121N Pag. 1.11	 50126N Pag. 1.11	 50130N Pag. 1.12	 50200N Pag. 1.12	 50211N Pag. 1.12	 50216N Pag. 1.13
 50223N Pag. 1.13	 50226N Pag. 1.13	 50230N Pag. 1.14	 50310N Pag. 1.14	 50500N Pag. 1.14	 50510N Pag. 1.14	 50550N Pag. 1.15	 50560N Pag. 1.15	 51410 Pag. 1.15
 51420 Pag. 1.16	 51430 Pag. 1.16	 51440 Pag. 1.16	 50600 Pag. 1.17	 50610 Pag. 1.17	 50625 Pag. 1.17	 50700N Pag. 1.17	 55800N Pag. 1.18	 55801 Pag. 1.18
 55802 Pag. 1.18	 50900 Pag. 1.20	 50980 Pag. 1.20	 50990 Pag. 1.20	 50006 Pag. 1.20				

RACCORDI AUTOMATICI

PUSH-IN FITTINGS

STECKVERSCHRAUBUNGEN

RACCORDS INSTANTANÉS

RACORDAJE AUTOMÁTICO

CONEXÕES PUSH-IN



Serie 50000

Da 40 anni Aignep studia, concepisce e realizza sistemi di connessioni per pneumatica e fluidica. La serie 50.000, prima versione istantanea, lanciata da Aignep, è l'espressione chiara della tecnologia affidabile e largamente provata nelle applicazioni pneumatiche.

Principali vantaggi

- Connessione e sconnesione istantanea
- Pieno passaggio e tenuta al vuoto grazie a guarnizioni sagomate
- Tre tipologie di filettature, BSPP, BSPT (universal short) e Metrica
- Robustezza perché realizzato in metallo
- Vasta gamma a disposizione per soddisfare le installazioni più esigenti
- Silicon Free

Applicazioni

- Automazione Pneumatica
- Automotive
- Industria tessile, imballaggio
- Circuiti aria compressa
- Vuoto

For over 40 years Aignep has developed and manufactured fittings for compressed air and fluidtechnology.

The 50.000 serie is the first line launched on the market from Aignep. It is the icon of quality, reliability and endurance in the pneumatic field.

Main advantages

- Quick connection and disconnection
- Full Flow and Vacuum resistant tank to special shaped seals
- 3 threads available, BSPP, BSPT (universal short) & Metric
- Metal Robustness
- Wide Range
- Silicon Free

Applications

- Pneumatic Automation
- Automotive
- Textile, Packaging
- Compressed Air Circuit
- Vacuum

Seit über 40 Jahren entwickelt und produziert Aignep Verschraubungen für Druckluft und Fluidtechnik.

Die 50.000er-Serie von Aignep wurde als erste Version auf dem Markt eingeführt. Sie ist Symbol für Qualität, Zuverlässigkeit und bewährter Technologie im pneumatischen Bereich.

Hauptvorteile

- Schnelle Verbindung und Trennung
- Voller Durchfluss und Vakuumfestigkeit, dank spezieller Formdichtungen
- Drei Gewindearten, BSPP, BSPT (universal kurz) und metrisch
- Robustes Metall
- Große Auswahl, auch für anspruchsvollste Installationen.
- Silikonfrei

Anwendungen

- Pneumatische Automation
- Automobil-Industrie
- Textil-, Verpackungsindustrie
- Druckluftkreislauf
- Vakuum

Depuis 40 ans, Aignep développe et fabrique des raccords pour l'air comprimé et pour tous fluides industriels.

La série 50.000 est la première gamme lancée sur le marché par Aignep. C'est une des références en terme de qualité, de fiabilité et d'endurance pour les applications pneumatiques.

Principaux avantages

- Connexion et déconnexion instantanée
- Plein débit et tenue au vide industriel grâce à des joints de forme
- 3 filetages disponibles, BSPP, BSPT (universal court) et Métrique
- Robustesse Métallique
- Large gamme
- Sans silicone

Applications

- Automatismes Pneumatiques
- Automobile
- Textile, Emballage
- Circuit d'Air comprimé
- Vide

Por más de 40 años Aignep estudia, concibe y fabrica sistemas de conexión para neumática y fluidica.

La serie 50.000, primera versión instantánea, lanzada por Aignep, es la expresión más clara de la tecnología fiable y ampliamente probada en las aplicaciones neumáticas.

Principales ventajas

- Conexión y desconexión instantánea
- Paso total y estanqueidad al vacío gracias a las juntas moldeadas
- Tres tipos de roscas, BSPP, BSPT (universal short) y métricas
- Robustez, realizado en metal
- Amplia gama disponible para satisfacer las instalaciones más exigentes
- Libre de silicona

Aplicaciones

- Automatización Neumática
- Automoción
- Industria textil, envasado
- Circuitos de aire comprimido
- Vacío

Por mais de 40 anos, a Aignep desenvolveu e fabricou conexões para ar comprimido e fluidos.

A série 50.000 é a primeira linha lançada no mercado pela Aignep. Ela é um ícone da qualidade, confiabilidade e durabilidade no campo da pneumática.

Principais vantagens

- Rápida conexão e desconexão.
- Vazão total e resistência ao vácuo graças ao design especial das suas vedações
- 3 tipos de rosca disponíveis: BSPP, BSPT (universal short) & Métrica
- Robustez Metálica
- Grande Range de itens
- Livre de Silicone

Aplicações

- Automação Pneumática
- Automotiva
- Têxtil, Embalagens
- Circuitos de Ar Comprimido
- Vácuo



CARATTERISTICHE TECNICHE

TECHNICAL CHARACTERISTICS
TECHNISCHE ANGABEN
CARACTÉRISTIQUES TECHNIQUES
CARACTERÍSTICAS TÉCNICAS
CARACTERÍSTICAS TÉCNICAS



Norma di Riferimento

Reference standard

Entspricht der Norm

Norme de référence

Normativa de referencia

Norma de referència

1907/2006

REACH ✓

2011/65/CE

RoHS ✓

PED

2014/68/UE

ISO
14743:2004

SILICON
FREE

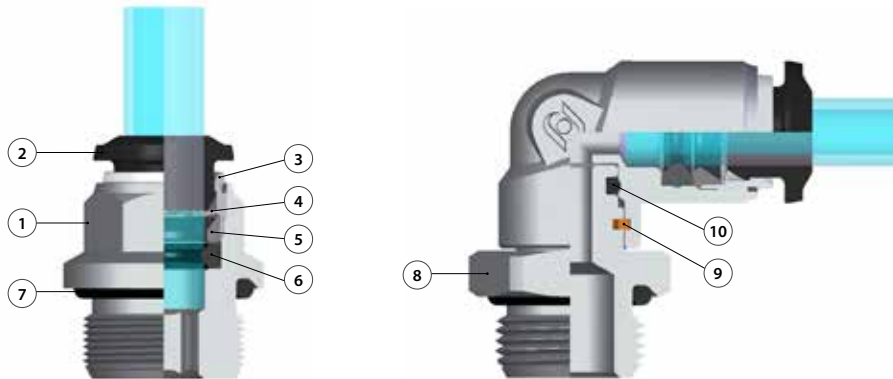

Materiali e Componenti

IT

- 1 Corpo in ottone nichelato
- 2 Spintore sgancio tubo in resina acetatica
- 3 Capsula in ottone nichelato
- 4 Pinza d'aggraffaggio in acciaio inox AISI 301
- 5 Anello di posizionamento in tecnopolimero
- 6 Guarnizione sagomata in NBR
- 7 Guarnizione filetto in NBR
- 8 Basetta Filettata in Ottone Nichelato
- 9 Seeger
- 10 Guarnizione in NBR

Component Parts and Materials

GB

- 1 Nickel-plated brass Body
- 2 Acetatic resin Collet
- 3 Nickel-plated brass Capsule
- 4 Steel AISI 301 Clamping washer
- 5 Technopolymeric positioning ring
- 6 NBR Molded seal
- 7 NBR Thread packing
- 8 Base Threaded Nickel Plated Brass
- 9 Seeger
- 10 NBR seal

Komponenten und Materialien

DE

- 1 Körper Messing vernickelt
- 2 Rohr Lösering Acetal
- 3 Haltering Messing vernickelt
- 4 Zahnscheibe Edelstahl AISI 301
- 5 Positioniererring Technopolymer
- 6 Lippendichtung nbr
- 7 Gewindeabdichtung nbr
- 8 Gewindebasis Messing vernickelt
- 9 Seeger
- 10 Lippendichtung NBR

Matériaux et Composants

FR

- 1 Corps: Laiton nickelé
- 2 Poussoir: Résine acétal
- 3 Capsule de retenue: Laiton nickelé
- 4 Rondelle d'accrochage: AISI 301
- 5 Anneau de positionnement: Technopolymère
- 6 Joint à lèvres: NBR
- 7 Joint d'étanchéité du filetage: NBR
- 8 Bague de sécurité en laiton nickelé
- 9 Seeger
- 10 Joint en NBR

Materiales y Componentes

ES

- 1 Cuerpo en latón niquelado
- 2 Anillo de extracción tubo en resina acetálica
- 3 Cápsula en latón niquelado
- 4 Pinza de agarre en acero inox AISI 301
- 5 Anillo de posicionamiento en tecnopolimero
- 6 Junta de forma en NBR
- 7 Junta rosca en NBR
- 8 Base roscada en latón niquelado
- 9 Seeger
- 10 Junta en NBR

Materiais e Componentes

PT

- 1 Corpo em latão niquelado
- 2 Anilha de liberação do tubo em resina acetálica
- 3 Cápsula de latão niquelado
- 4 Pinça de travamento em aço-inox AISI 301
- 5 Anel de posicionamento em tecnopolimero
- 6 Vedação em NBR
- 7 Vedação da rosca em NBR
- 8 Base roscada em latão niquelado
- 9 Seeger
- 10 Vedação em NBR



Pressioni

Pressures

Druckbereich

Pressions

Presiones

Pressões

- 0.99 bar (-0.099 MPa)

20 bar (2.0 MPa)



Temperature

Temperatures

Temperatur

Températures

Temperaturas

Temperaturas

- 20 °C

+ 80 °C



Fluidi compatibili

Aria compressa / Vuoto

Fluids

Compressed air / Vacuum

Geeignete Medien

Druckluft / Vakuum

Fluides compatibles

Air comprimé / Vide

Fluidos compatibles

Aire comprimido / Vacío

Fluidos compatíveis

Ar comprimido / Vácuo



Tubi di Collegamento

IT

Tubi in materiale plastico:

PA6, PA11, PA12, Polietilene, *Poliuretano, PTFE, FEP.

*Per tubi in Poliuretano é consigliata una durezza di 98 shore.

Connection Tubes

GB

Plastic tubes:

PA6, PA11, PA12, Polyethylene, *Polyurethane, PTFE, FEP.

*For Polyurethane hoses it is required a minimum hardness of 98 shore.

Geeignete Rohre

DE

Kunststoffrohre:

PA6, PA11, PA 12, Polyethylene, *Polyurethan, PTFE, FEP.

*Für Polyurethan Rohre ist eine Härte von 98 Shore empfohlen.

Tubes Conseillés

FR

Tubes plastiques:

PA6, PA11, PA12, Polyéthylène, *Polyuréthane, PTFE, FEP.

*Pour les tubes en polyuréthane, il est conseillé une dureté de 98 Shore.

Tubos de Conexión

ES

Tubos en material plástico:

PA6, PA11, PA 12, Polietileno, *Poliuretano, PTFE, FEP.

*Para tubos en poliuretano es aconsejada una dureza de 98 shore.

Tubos de Conexão

PT

Tubos em material plástico:

PA6, PA11, PA12, Polietileno, *Poliuretano, PTFE, FEP.

*Para tubos em Poliuretano é requerida uma dureza de 98 shore.



<p>Filettatura IT</p> <p>Gas conica "UNIVERSAL SHORT". Gas conica conforme ISO 7.1, BS 21, DIN 2999. Gas cilindrica conforme ISO 228 Classe A. Metrica conforme ISO R/262.</p>	<p>Threads GB</p> <p>"UNIVERSAL SHORT" Tapered thread. Tapered gas in conformity with ISO 7.1, BS 21, DIN 2999. Parallel gas in conformity with ISO 228 Class A. Metric in conformity with ISO R/262.</p>	<p>Gewindearten DE</p> <p>Konisches Gewinde "UNIVERSAL SHORT". Konisches Gewinde nach Norm ISO 7.1, BS 21, DIN 2999. Zylindrisches Gewinde nach Norm ISO 228 Classe A. Metrisches Gewinde nach Norm ISO R/262.</p>
<p>Filetages FR</p> <p>Filetage conique "UNIVERSAL SHORT". Filetage conique conforme: ISO 7.1, BS 21, DIN 2999. Filetage cylindrique conforme: ISO 228 Classe A. Filetage métrique conforme: ISO R/262.</p>	<p>Roscas ES</p> <p>Gas cónica "UNIVERSAL SHORT". Gas cónica conforme ISO 7.1, BS 21, DIN 2999. Gas cilíndrica conforme ISO 228 Clase A. Métrica conforme ISO R/262.</p>	<p>Roscas PT</p> <p>Gas cónica "UNIVERSAL SHORT". Gas cónica conforme ISO 7.1, BS 21, DIN 2999. Gas paralela conforme ISO 228 Classe A. Métrica conforme ISO R/262.</p>



UNIVERSAL SHORT

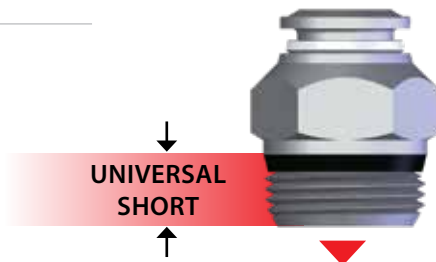

<p>NPT NPTF</p> <p>Conica Tapered Konisch Conique Cónica Cônica</p>	<p>ISO 7 BSPP</p> <p>Cilindrica Paralell Zylindrisch Cylindrique Cilíndrica Paralela</p>	<p>ISO 7 BSPT PT</p> <p>Conica Tapered Konisch Conique Cónica Cônica</p>	<p>ISO 228 BSP PF</p> <p>Cilindrica Paralell Zylindrisch Cylindrique Cilíndrica Paralela</p>
---	--	---	---

<p>"UNIVERSAL SHORT" IT</p> <p>La filettatura conica "UNIVERSAL SHORT" è progettata per soddisfare le seguenti caratteristiche:</p> <ul style="list-style-type: none"> • ridurre la lunghezza d'ingombro; • ridurre la chiave rispetto ad alcuni raccordi con filettature cilindriche; • consentire l'accoppiamento con diversi standard di filettature femmina sia coniche che cilindriche. 	<p>"UNIVERSAL SHORT" GB</p> <p>The "UNIVERSAL SHORT" taper thread has been designed to offer the following advantages to the users:</p> <ul style="list-style-type: none"> • reduced overall length; • smaller hex dimensions compared to the parallel threads; • to allow the assembly with different female threads both taper as well as parallel. 	<p>"UNIVERSAL SHORT" DE</p> <p>Das konische Gewinde "UNIVERSAL SHORT" ist so konzipiert, dass folgende Vorteile erzielt werden:</p> <ul style="list-style-type: none"> • Reduzierung der Länge des Gewindes - kürzere Montagezeit; • Reduzierung der Schlüsselweite im Vergleich von Verschraubungen mit zylindrischen Gewinden - geringerer Lochabstand; • Ermöglicht den Einsatz in verschiedene Gewindearten, sowie in konische- und zylindrische Innengewinde.
<p>"UNIVERSAL SHORT" FR</p> <p>Le filetage conique "UNIVERSAL SHORT" a été conçu pour satisfaire les exigences suivantes:</p> <ul style="list-style-type: none"> • réduire la longueur d'encombrement; • réduire les dimensions hexagonales par rapport au filetage cylindrique; • permettre le montage avec divers taraudages standards soit coniques soit cylindriques. 	<p>"UNIVERSAL SHORT" ES</p> <p>La rosca cónica "UNIVERSAL SHORT" ha sido proyectada para satisfacer las siguientes características:</p> <ul style="list-style-type: none"> • reducir la longitud; • reducir la llave respecto a algunos racores con rosca cilíndrica; • permitir el acoplamiento con diferentes standard de roscas hembra sean cónicas o cilíndricas. 	<p>"UNIVERSAL SHORT" PT</p> <p>A rosca cónica "UNIVERSAL SHORT" é projetada para satisfazer às seguintes características:</p> <ul style="list-style-type: none"> • reduzir o comprimento da conexão; • reduzir o dimensional com relação às roscas paralelas; • permitir o acoplamento da conexão a diferentes tipos de rosca fêmea, sejam elas cónicas ou paralelas.



Inclinate
Inclined
Geneigt
Incliné
Inclinada
Inclinadas



Concave
Concave
Konkav
Concave
Cóncava
Côncavas



Convexe
Convex
Konvex
Convexe
Convexa
Convexas

<p>IT</p> <p>Consentire una completa tenuta anche su superfici non perfettamente piane, concave, convesse o inclinate, con diversi smussi o raggi.</p>	<p>GB</p> <p>To ensure the right tightening also with surfaces not perfectly flat, without spot-facing, concave convex and with different kinds of chamfers or radius.</p>	<p>DE</p> <p>Eine vollständige Abdichtung ist auch auf unebenen Flächen, wie geneigt, konkav oder konvex und mit unterschiedlichen Radien oder Fasen gewährleistet.</p>
<p>FR</p> <p>Pour permettre une parfaite étanchéité même sur surfaces non planes, concaves, convexas ou inclinées et avec différents chanfreins ou rayons.</p>	<p>ES</p> <p>Consentir una completa estanqueidad incluso en superficies no perfectamente planas, cóncavas, convexas o inclinadas, con diferentes ángulos o radios.</p>	<p>PT</p> <p>Permite um aperto correto em superfícies não perfeitamente planas, côncavas, convexas ou inclinadas, com diferentes chanfros ou raios.</p>



Coppia di serraggio

Torque specifications

Angaben Drehmoment

Couple de serrage

Par de apriete

Especificações de Torque



ISO 228

MISURA MEASURE GRÖSSE DIMENSIONS MEDIDA MEDIDA	COPPIA CONSIGLIATA Nm RECOMMENDED TORQUE Nm EMPFOHLENES DREHMOMENT Nm COUPLE DE SERRAGE Nm PAR ACONSEJADO Nm TORQUE RECOMENDADO Nm	COPPIA DI ROTTURA Nm BREAKING TORQUE Nm ABSCHERDREHMOMENT Nm COUPLE DE RUPTURE Nm PAR DE ROTURA Nm TORQUE DE RUPTURA Nm
M5	0,8	3,2
M8	3	8
1/8	3	8
1/4	9	30
3/8	10	60
1/2	12	50



"UNIVERSAL SHORT"

MISURA MEASURE GRÖSSE DIMENSIONS MEDIDA MEDIDA	COPPIA MINIMA CONSIGLIATA Nm RECOMMENDED MINIMUM TORQUE Nm EMPFOHLENES DREHMOMENT Nm COUPLE DE SERRAGE Nm PAR MÍNIMO ACONSEJADO Nm TORQUE MÍNIMO RECOMENDADO Nm	COPPIA MASSIMA CONSIGLIATA Nm RECOMMENDED MAX TORQUE Nm ABSCHERDREHMOMENT Nm COUPLE DE RUPTURE Nm PAR MÁXIMO ACONSEJADO Nm TORQUE MÁXIMA RECOMENDADO Nm
1/8	5	7
1/4	5	7
3/8	5	7
1/2	5	7

I valori di rottura possono variare in base all'articolo

Breaking values may vary according to the item
Die maximal werte dienen nur zu informationszwecken
Les valeurs maximales sont présentées à titre indicatif
Los valores de rotura pueden variar en función del artículo
Os valores de ruptura podem variar em função do item

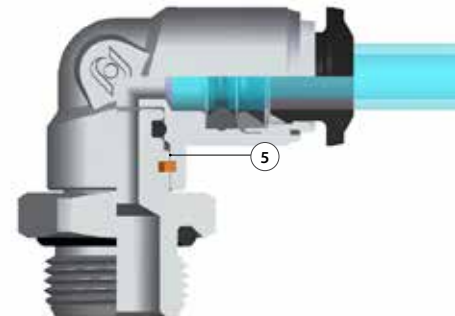
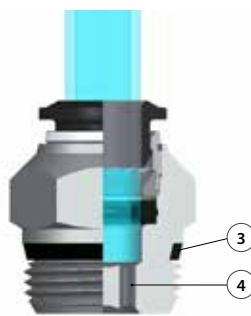
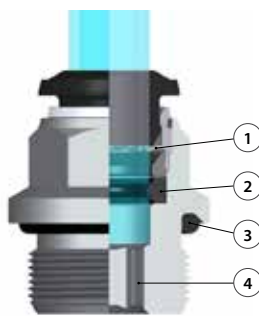

Vantaggi

IT

- 1 La pinza in acciaio inox garantisce il perfetto aggiraffaggio di tubi di qualsiasi materiale senza danneggiarne la superficie. Il collegamento tra tubo e raccordo assicura una tenuta totale anche in condizioni di urti e vibrazioni.
- 2 La particolare geometria della guarnizione permette inoltre l'utilizzo dei raccordi anche con il vuoto.
- 3 Tutte le filettature di questa serie sono state dotate di elementi di tenuta che permettono l'immediato utilizzo dei raccordi riducendo notevolmente i tempi di installazione.
- 4 Tutti i raccordi dritti possono essere montati anche con chiave esagonale ed è possibile utilizzarli anche in spazi molto ridotti.
- 5 Raccordo orientabile con anello di sicurezza interno. Garantisce maggiore durata alla rotazione e trazione.

Advantages

GB

- 1 The washer is made in stainless steel ensures the perfect tube clamping with every kinds of materials without damage the surface. The connection between the tube and the fitting ensure a total tightness even in severe conditions such as impact and vibrations.
- 2 The particular geometric shape of the seal ensure the perfect tightness even with vacuum.
- 3 All of threads from this range have been equipped with tightening parts which allow the direct assembly of the fittings, reducing the installation time.
- 4 All the straight fittings can be assembled also with Allen wrench and it is possible to use them in reduced spaces.
- 5 Orienting fitting with safety ring inside. Improved durability to the rotation and traction.

Vorteile

DE

- 1 Konisches Gewinde "kurz" Die Zahnscheibe sorgt für eine perfekte Halterung des Rohres ohne die Oberfläche zu beschädigen. Die Dichtigkeit zwischen Rohr und Verschraubung ist auch bei Erschütterungen und Vibrationen gewährleistet.
- 2 Die besondere Geometrie der Dichtung ermöglicht auch die Anwendung der Verschraubungen in Verbindung mit Vakuum.
- 3 Alle Verschraubungen in dieser Serie sind mit Gewindeabdichtungen ausgestattet, die den sofortigen Einsatz ermöglichen und daher die Montagezeit stark reduzieren.
- 4 Alle geraden Verschraubungen können auch mit Inbusschlüsseln montiert werden, daher kleiner Lochabstand möglich.
- 5 Flexible Montage mit Sicherungsring innen. Verbesserte Beständigkeit gegenüber der Drehung und Traktions.

Avantages

FR

- 1 La rondelle en acier inoxydable garantit la parfaite tenue du tube quelle que soit la matière et sans l'endommager. La connexion entre le tube et le raccord assure une étanchéité totale même dans des conditions d'impact ou de vibrations.
- 2 La spécificité géométrique du joint permet l'utilisation des raccords avec le vide.
- 3 Tous les filetages de cette série sont équipés d'éléments d'étanchéité qui permettent l'utilisation immédiate des raccords réduisant ainsi le temps d'installation.
- 4 Tous les raccords droits peuvent être aussi montés avec une clé hexagonale pour permettre une utilisation dans des espaces réduits.
- 5 Accessoire de fixation réglable avec anneau de sécurité à l'intérieur. Amélioration de la durée de la rotation et de traction.

Ventajas

ES

- 1 La pinza en acero inoxidable garantiza el perfecto agarre del tubo de cualquier material sin perjudicar la superficie. La conexión entre tubo y racor asegura una estanqueidad total aun en condiciones de impacto o vibración.
- 2 La particular geometría de la junta garantiza una perfecta estanqueidad incluso en vacío.
- 3 Todas las rosas de esta serie están fabricadas con junta de cierre que permite la inmediata utilización del racor reduciendo notablemente el tiempo de instalación.
- 4 Todos los racores rectos pueden montarse también con llave hexagonal y es posible utilizarlos incluso en espacios muy reducidos.
- 5 Montaje ajustable con sistema de seguridad interior. La mejora de la durabilidad a la rotación y tracción.

Vantagens

PT

- 1 A pinça em aço-inox garante o perfeito travamento do tubo de qualquer material sem danificar a superfície do mesmo. A conexão entre o tubo e a conexão assegura uma vedação total também em condições de impactos e vibrações.
- 2 A geometria particular da vedação permite a utilização da conexão também para aplicações com vácuo.
- 3 Todas as rosas desta série são dotadas de elementos de vedação, o que permite a imediata utilização das conexões, reduzindo notavelmente o tempo de instalação.
- 4 Todas as conexões retas podem ser montadas também com chave allenorando possível montagem das mesmas em espaços bem reduzidos.
- 5 Montagem ajustável com anel de segurança dentro. A durabilidade melhorada para a rotação e tração.

50000N

RACCORDO DIRITTO MASCHIO "UNIVERSAL SHORT"

STRAIGHT MALE ADAPTOR "UNIVERSAL SHORT"

GERADE EINSCHRAUBVERSCHRAUBUNG KONISCH "UNIVERSAL SHORT"

RACCORD DROIT MÂLE, CONIQUE "UNIVERSAL SHORT"

RACOR RECTO MACHO CÔNICO "UNIVERSAL SHORT"

CONEXÃO RETA COM ROSCA "UNIVERSAL SHORT"

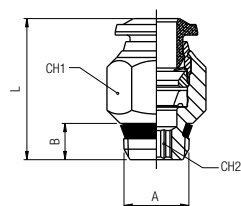

Code	Tube	A	B	L	CH1	CH2	Pack.
55000 00 001	4	1/8	5.5	18	11	3	10
55000 00 013	4	1/4	7	19	14	3	10
55000 00 002	5	1/8	5.5	20	11	4	10
55000 00 003	5	1/4	7	20	14	4	10
55000 00 004	6	1/8	5.5	21.5	13	4	10
55000 00 005	6	1/4	7	21	14	4	10
55000 00 014	6	3/8	7.5	23	17	4	10
55000 00 015	6	1/2	9	23.5	21	4	10
55000 00 006	8	1/8	5.5	24.5	14	5	10
55000 00 007	8	1/4	7	22	14	6	10
55000 00 008	8	3/8	7.5	23	17	6	10
55000 00 016	8	1/2	9	23.5	21	6	10
55000 00 009	10	1/4	7	28	17	7	10
55000 00 010	10	3/8	7.5	25.5	17	8	10
55000 00 017	10	1/2	9	26	21	8	10
55000 00 011	12	1/4	7	31.5	20	7	10
55000 00 012	12	3/8	7.5	29.5	20	9	10
55000 00 018	12	1/2	9	31.5	21	10	10
55000 00 019	14	3/8	7.5	32.5	21	9	10
55000 00 020	14	1/2	9	31.5	21	10	10

50010N

RACCORDO DIRITTO MASCHIO ESAGONO INCASSATO

STRAIGHT MALE ADAPTOR WITH EXAGON EMBEDDED

GERADE EINSCHRAUBVERSCHRAUBUNG MIT INNENSECHSKANT

RACCORD DROIT MÂLE, 6-PANS INTERIEUR

RACOR RECTO MACHO CÔNICO HEXÁGONO INTERIOR

CONEXÃO RETA COM SEXTAVADO INTERNO

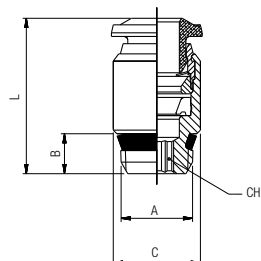

Code	Tube	A	B	C	L	CH	Pack.
50010 00 N08	3	M5	4	8	19	2.5	10
50010 00 N01	4	M5	4	9.5	19.5	2.5	10
50010 00 N02	4	1/8	5.5	11	18	3	10
50010 00 N09	4	M7x1	5	10	21	2.5	10
50010 00 N07	6	M5	4	12	24.5	2.5	10
50010 00 N11	6	M6x1	5	12	24	2.5	10
50010 00 N03	6	1/8	5.5	12	21.5	4	10
50010 00 N04	6	1/4	7	14	21	4	10
50010 00 N05	8	1/8	5.5	14	25	5	10
50010 00 N06	8	1/4	7	14	22.5	6	10

50020N

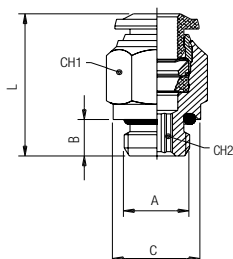
New
RACCORDO DIRITTO MASCHIO CILINDRICO
STRAIGHT MALE ADAPTOR (PARALLEL)
GERADE EINSCHRAUBVERSCHRAUBUNG ZYLINDRISCH
RACCORD DROIT MÂLE, CYLINDRIQUE
RACOR RECTO MACHO CILÍNDRICO CON TÓRICA
CONEXÃO RETA COM ROSCA PARALELA

Code	Tube	A	B	C	L	CH1	CH2	Pack.
50020 00 N21	3	M5	4	8	19	8	2	10
50020 00 N34	4	M3	3	10	21	8	-	10
50020 00 N01	4	M5	4	8	21	10	2	10
50020 00 N02	4	1/8	6	13	20	10	3	10
50020 00 N22	4	1/4	8	16	19.5	16	3	10
50020 00 N41	4	3/8	8	20	18	20	3	10
50020 00 N18	5	M5	4	8	23.5	12	2	10
50020 00 N19	5	1/8	6	13	22	12	4	10
50020 00 N36	5	1/4	8	16	22	12	4	10
50020 00 N20	6	M5	4	10	24.5	13	2	10
50020 00 N03	6	1/8	6	13	23.5	13	4	10
50020 00 N04	6	1/4	8	16	23.5	13	4	10
50020 00 N27	6	3/8	9	20	25	13	4	10
50020 00 N28	6	1/2	10	25	27	13	4	10
50020 00 N05	8	1/8	6	13	25	14	5	10
50020 00 N06	8	1/4	8	16	23	14	6	10
50020 00 N07	8	3/8	9	20	24	14	6	10
50020 00 N29	8	1/2	10	25	26.5	14	6	10
50020 00 N08	10	1/4	8	16	30.5	17	6	10
50020 00 N09	10	3/8	9	20	27.5	17	8	10
50020 00 N31	10	1/2	10	25	27	17	8	10
50020 00 N32	12	1/4	8	16	34.5	20	6	10
50020 00 N11	12	3/8	9	20	34	20	8	10
50020 00 N23	12	1/2	10	25	31	22	10	10
50020 00 N24	14	3/8	9	20	35	21	10	10
50020 00 N25	14	1/2	10	25	32	22	11	10
50020 00 N37	6	M8x1	5.5	12	24.5	13	3	10
50020 00 N38	6	M10x1	5.5	13	23	13	4	10
50020 00 N12	6	M12x1	8	15	23.5	13	4	10
50020 00 N13	6	M12x1.25	8	15	23.5	13	4	10
50020 00 N14	6	M12x1.5	8	15	23.5	13	4	10
50020 00 N39	8	M8x1	5.5	12	25.5	14	4	10
50020 00 N40	8	M10x1	5.5	13	25.5	14	4	10
50020 00 N17	8	M12x1.5	8	15	27.5	14	6	10

50030N

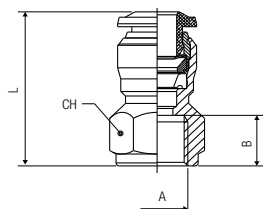
RACCORDO DIRITTO FEMMINA
STRAIGHT FEMALE ADAPTOR
AUFSCHRAUBVERSCHRAUBUNG
RACCORD DROIT, TARAUE
RACOR RECTO HEMBRA
CONEXÃO RETA COM ROSCA FÊMEA

Code	Tube	A	B	L	CH	Pack.
50030 00 N07	3	M5	5.5	18.5	9	10
50030 00 N08	4	M5	5.5	21	11	10
50030 00 N01	4	1/8	8.5	24	13	10
50030 00 N09	4	1/4	11	27.5	16	10
50030 00 N06	5	1/8	8.5	26.5	13	10
50030 00 N02	6	1/8	8.5	26	13	10
50030 00 N03	6	1/4	11	29.5	16	10
50030 00 N04	8	1/8	8.5	27	15	10
50030 00 N05	8	1/4	11	29.5	17	10
50030 00 N10	8	3/8	12	32	19	10
50030 00 N11	10	1/4	11	32	18	10
50030 00 N12	10	3/8	12	33.5	19	10
50030 00 N13	10	1/2	15	39	24	10
50030 00 N14	12	3/8	12	36	21	10
50030 00 N15	12	1/2	15	41	24	10

50040N

RACCORDO DIRITTO INTERMEDIO

STRAIGHT CONNECTOR
 VERBINDUNGSVERSCHAUBUNG
 RACCORD UNION DOUBLE
 RACOR RECTO INTERMEDIO
 CONEXÃO RETA TUBO-TUBO

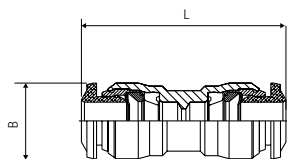

Code	Tube	Tube	L	B	Pack
50040 00 N09	3		26	8.5	10
50040 00 N01	4		30.5	10.5	10
50040 00 N08	5		33	11.5	10
50040 00 N02	6	4	32	12.5	10
50040 00 N03	6		34	12.5	10
50040 00 N04	8	6	35	14.5	10
50040 00 N05	8		36	14.5	10
50040 00 N11	10	8	40.5	17.5	10
50040 00 N06	10		42	17.5	10
50040 00 N12	12	10	45.5	20.5	10
50040 00 N07	12		47	20.5	10
50040 00 N10	14		49	21.5	10

50050N

RACCORDO DIRITTO INTERMEDIO DI ATTRAVERSAMENTO

BULKHEAD CONNECTOR
 SCHOTTVERSCHAUBUNG
 RACCORD TRAVERSÉE DE CLOISON
 RACOR RECTO INTERMEDIO PASATABIQUES
 CONEXÃO PASSA-MURO RETA TUBO-TUBO

New

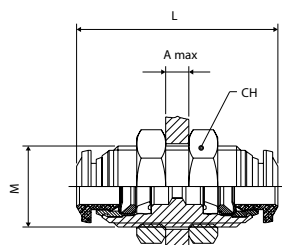

Code	Tube	M	L	CH	A max	Pack.
50050 00 N07	3	M10x1	26	14	5	10
50050 00 N01	4	M12x1	31.5	17	7	10
50050 00 N06	5	M14x1	33	17	7	10
50050 00 N02	6	M14x1	35	17	9.5	10
50050 00 N09	8-6	M16x1	37	19	10.5	10
50050 00 N03	8	M16x1	37	19	10.5	10
50050 00 N10	10-6	M20x1	43	24	11.5	10
50050 00 N11	10-8	M20x1	43	24	12.5	10
50050 00 N04	10	M20x1	43	24	12.5	10
50050 00 N05	12	M22x1	48	26	16.5	10
50050 00 N08	14	M23x1	49	27	16.5	10

50055N

RACCORDO DIRITTO DI ATTRAVERSAMENTO FEMMINA

FEMALE BULKHEAD CONNECTOR
 SCHOTTVERSCHAUBUNG INNENGEWINDE
 TRAVERSÉE DE CLOISON FEMELLE
 RACOR RECTO INTERMEDIO PASATABIQUES HEMBRA
 CONEXÃO PASSA-MURO RETA FEMEA

New

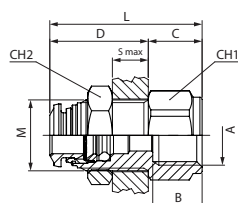

Code	Tube	A	B	M	S max	CH1	CH2	C	D	L	Pack.
50055 00 N01	4	1/8	8.5	M12X1	7	15	17	10	19	29	10
50055 00 N02	6	1/8	8.5	M14X1	8	16	17	10	21	31	10
50055 00 N03	6	1/4	11	M14X1	8	16	17	12	21	33	10
50055 00 N04	8	1/8	8.5	M16X1	8	18	19	10	22	32	10
50055 00 N05	8	1/4	11	M16X1	8	18	19	12	22	34	10
50055 00 N06	10	3/8	12	M20X1	9.5	24	24	14	25.5	39.5	10
50055 00 N07	12	3/8	12	M22X1	10.5	24	26	15	27.5	42.5	10
50055 00 N08	12	1/2	15	M22X1	10.5	24	26	17	27.5	44.5	10

50465N

ADATTATORE DIRITTO INTERMEDIO DI ATTRAVERSAMENTO

BULKHEAD CONNECTOR
 SCHOTTVERSCHAUBUNG
 ADAPTEUR DROIT TRAVERSEE DE CLOISON
 RACOR RECTO INTERMEDIO PASATABIQUES
 CONEXÃO PASSA-MURO RETA TUBO-TUBO

New

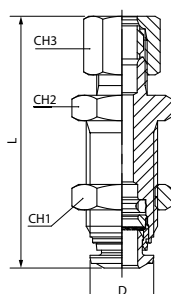

Code	Tube	L	D	CH1	CH2	CH3	Pack.
50465 00 N02	6	49.5	12.5	13	17	17	10
50465 00 N03	8	52	14	14	19	19	10
50465 00 N04	10	59	17	19	24	24	10

50100N

RACCORDO A L MASCHIO CONICO

ELBOW MALE ADAPTOR (TAPER)

WINKELVERSCHRAUBUNG KONISCH (NICHT DREHBAR)

EQUERRE NON ORIENTABILE MÂLE, CONIQUE

RACOR A L MACHO CÔNICO

CONEXÃO MACHO EM "L" COM ROSCA CÔNICA

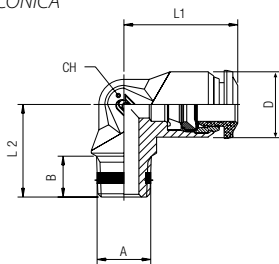

Code	Tube	A	B	L1	L2	CH	D	Pack.
50100 00 N01	4	M5	5	17	15	9	10	10
50100 00 N02	4	1/8	7.5	17	15.5	9	10	10
50100 00 N10	5	M5	5	20	17	11	12.5	10
50100 00 N11	5	1/8	7.5	20	17.5	11	12.5	10
50100 00 N03	6	1/8	7.5	21	17.5	11	12.5	10
50100 00 N12	6	1/4	11	21	21.5	11	12.5	10
50100 00 N04	8	1/8	7.5	22.5	19	13	14	10
50100 00 N05	8	1/4	11	22.5	21.5	13	14	10
50100 00 N06	10	1/4	11	26.5	24.5	16	17	10
50100 00 N07	10	3/8	11.5	26.5	24	16	17	10
50100 00 N08	12	1/4	11	30.5	28	19	21.5	10
50100 00 N09	12	3/8	11.5	30.5	28	19	21.5	10

50106N

New

RACCORDO A L ORIENTABILE FEMMINA

ORIENTING ELBOW FEMALE ADAPTOR

AUFSCRAUB-WINKELSCHRAUBUNG (DREHBAR)

EQUERRE ORIENTABLE FEMELLE

RACOR A L ORIENTABLE HEMBRA

CONEXÃO EM "L" ORIENTÁVEL COM ROSCA FÊMEA

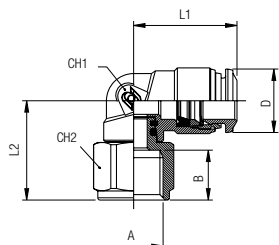

Code	Tube	A	B	L1	L2	CH1	CH2	D	Pack.
50106 00 N01	4	1/8	8.5	18	19	9	13	10	10
50106 00 N02	4	1/4	11	18	21.5	9	16	10	10
50106 00 N03	6	1/8	8.5	21	20.5	11	13	12.5	10
50106 00 N04	6	1/4	11	21	23	11	16	12.5	10
50106 00 N05	8	1/8	8.5	22.5	22	12	13	14.5	10
50106 00 N06	8	1/4	11	22.5	24.5	12	16	14.5	10
50106 00 N07	8	3/8	12	22.5	24.5	12	13	14.5	10
50106 00 N09	10	1/4	11	26.5	25	14	19	17	10
50106 00 N10	10	3/8	12	26.5	28	14	19	17	10
50106 00 N11	12	1/2	15	31.5	34.5	16	24	20	10

50111N

RACCORDO A L ORIENTABILE MASCHIO "UNIVERSAL SHORT"

ORIENTING ELBOW MALE ADAPTOR "UNIVERSAL SHORT"

WINKELVERSCHRAUBUNG KONISCH (DREHBAR) "UNIVERSAL SHORT"

EQUERRE ORIENTABLE MÂLE, CONIQUE "UNIVERSAL SHORT"

RACOR A L ORIENTABLE MACHO CÔNICO "UNIVERSAL SHORT"

CONEXÃO MACHO EM "L" ORIENTÁVEL COM ROSCA "UNIVERSAL SHORT"

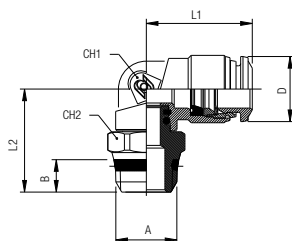

Code	Tube	A	B	L1	L2	CH	CH2	D	Pack.
50111 00 N01	4	1/8	5.5	18	19.5	9	13	10	10
50111 00 N02	4	1/4	7	18	21	9	15	10	10
50111 00 N03	5	1/8	5.5	20	21.5	11	13	12.5	10
50111 00 N04	6	1/8	5.5	21	21.5	11	13	12.5	10
50111 00 N05	6	1/4	7	21	23	11	15	12.5	10
50111 00 N06	8	1/8	5.5	22.5	24	12	13	14.5	10
50111 00 N07	8	1/4	7	22.5	24	12	15	14.5	10
50111 00 N08	8	3/8	7.5	22.5	24.5	12	17	14.5	10
50111 00 N09	8	1/2	9	22.5	27	12	21	14.5	10
50111 00 N10	10	1/4	7	26.5	26.5	14	16	17.5	10
50111 00 N11	10	3/8	7.5	26.5	24.5	14	17	17.5	10
50111 00 N12	10	1/2	9	26.5	27	14	21	17.5	10
50111 00 N13	12	3/8	7.5	31.5	26.5	16	20	21.5	10
50111 00 N14	12	1/2	9	31.5	29	16	21	21.5	10
50111 00 N15	14	3/8	7.5	31.5	27	16	20	21.5	10
50111 00 N16	14	1/2	9	31.5	29.5	16	21	21.5	10

50116N

RACCORDO A L ORIENTABILE MASCHIO CILINDRICO

ORIENTING ELBOW MALE ADAPTOR (PARALLEL)

WINKELVERSCHRAUBUNG ZYLINDRISCH (DREHBAR)

EQUERRE ORIENTABLE MÂLE, CYLINDRIQUE

RACOR A L ORIENTABLE MACHO CILÍNDRICO CON TÓRICA

CONEXÃO MACHO EM "L" ORIENTÁVEL COM ROSCA PARALELA

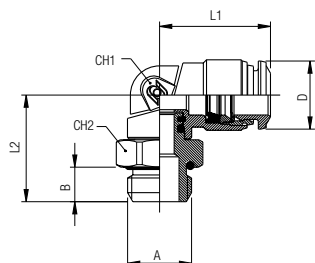

Code	Tube	A	B	L1	L2	CH1	CH2	D	Pack.
50116 00 N01	3	M5	3.5	16.5	17.5	9	8	10	10
50116 00 N02	4	M5	3.5	18	17.5	9	8	10	10
50116 00 N03	4	1/8	5.5	18	18	9	13	10	10
50116 00 N04	4	1/4	7	18	18	9	16	10	10
50116 00 N05	5	M5	3.5	20	20	11	11	12.5	10
50116 00 N06	5	1/8	5.5	20	20	11	13	12.5	10
50116 00 N07	6	M5	3.5	21	20	11	11	12.5	10
50116 00 N08	6	1/8	5.5	21	20	11	13	12.5	10
50116 00 N09	6	1/4	7	21	21.5	11	16	12.5	10
50116 00 N10	8	1/8	5.5	22.5	22.5	12	13	14.5	10
50116 00 N11	8	1/4	7	22.5	23	12	16	14.5	10
50116 00 N12	8	3/8	8	22.5	25	12	20	14.5	10
50116 00 N13	8	1/2	9.5	22.5	26.5	12	25	14.5	10
50116 00 N14	10	1/4	7	26.5	25.5	14	16	17.5	10
50116 00 N15	10	3/8	8	26.5	25	14	20	17.5	10
50116 00 N16	10	1/2	9.5	26.5	26.5	14	25	17.5	10
50116 00 N25	12	1/4	8	31.5	27.5	16	20	21.5	10
50116 00 N17	12	3/8	8	31.5	27	16	20	21.5	10
50116 00 N18	12	1/2	9.5	31.5	28.5	16	25	21.5	10
50116 00 N19	14	3/8	8	31.5	27.5	16	20	21.5	10
50116 00 N20	14	1/2	9.5	31.5	29	16	25	21.5	10
50116 00 N21	6	M12x1	7.5	20	22	11	16	12.5	10
50116 00 N22	6	M12x1.25	7.5	20	22	11	16	12.5	10
50116 00 N23	6	M12x1.5	7.5	20	22	11	16	12.5	10
50116 00 N24	8	M12x1.5	7.5	22.5	23.5	12	16	14.5	10

50121N

RACCORDO A L ORIENTABILE PROLUNGATO MASCHIO "UNIVERSAL SHORT"

EXTENDED ORIENTING ELBOW MALE ADAPTOR "UNIVERSAL SHORT"

VERLÄNGERTE WINKELVERSCHRAUBUNG KONISCH (DREHBAR) "UNIVERSAL SHORT"

EQUERRE PROLONGÉE ORIENTABLE MÂLE, CONIQUE "UNIVERSAL SHORT"

RACOR A L ORIENTABLE PROLONGADO MACHO CÓNICO "UNIVERSAL SHORT"

CONEXÃO EM "L" PROLONGADO ORIENTÁVEL COM ROSCA MACHO "UNIVERSAL SHORT"

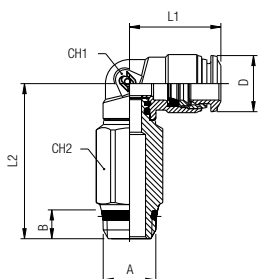

Code	Tube	A	B	L1	L2	CH1	CH2	D	Pack.
50121 00 N01	4	1/8	5.5	18	31.5	9	12	10	10
50121 00 N02	4	1/4	7	18	33	9	15	10	10
50121 00 N03	5	1/8	5.5	20	36	11	12	12.5	10
50121 00 N04	6	1/8	5.5	21	36	11	12	12.5	10
50121 00 N05	6	1/4	7	21	37.5	11	15	12.5	10
50121 00 N06	8	1/8	5.5	22.5	40.5	12	12	14.5	10
50121 00 N07	8	1/4	7	22.5	40.5	12	15	14.5	10
50121 00 N08	8	3/8	7.5	22.5	41	12	16	14.5	10
50121 00 N09	10	1/4	7	26.5	46	14	15	17.5	10
50121 00 N10	10	3/8	7.5	26.5	44	14	17	17.5	10

50126N

RACCORDO A L ORIENTABILE PROLUNGATO MASCHIO CILINDRICO

EXTENDED ORIENTING ELBOW MALE ADAPTOR (PARALLEL)

VERLÄNGERTE WINKELVERSCHRAUBUNG ZYLINDRISCH (DREHBAR)

EQUERRE PROLONGÉE ORIENTABLE MÂLE, CYLINDRIQUE

RACOR A L ORIENTABLE PROLONGADO MACHO CILÍNDRICO CON TÓRICA

CONEXÃO EM "L" PROLONGADO ORIENTÁVEL COM ROSCA MACHO PARALELA

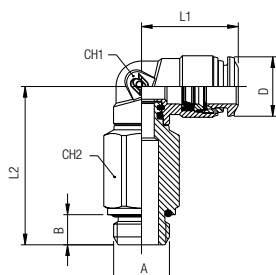

Code	Tube	A	B	L1	L2	CH1	CH2	D	Pack.
50126 00 N01	4	1/8	5.5	18	30	9	12	10	10
50126 00 N02	4	1/4	7	18	32	9	15	10	10
50126 00 N03	5	1/8	5.5	20	34.5	11	12	12.5	10
50126 00 N04	6	1/8	5.5	21	34.5	11	12	12.5	10
50126 00 N05	6	1/4	7	21	36	11	15	12.5	10
50126 00 N06	8	1/8	5	23	39	12	12	14.5	10
50126 00 N07	8	1/4	7	22.5	39.5	12	15	14.5	10
50126 00 N08	8	3/8	8	22.5	41.5	12	18	14.5	10
50126 00 N09	10	1/4	7	26.5	45	14	16	17.5	10
50126 00 N10	10	3/8	8	26.5	44.5	14	18	17.5	10

50130N

RACCORDO A L INTERMEDIO

ELBOW CONNECTOR
WINKELVERSCHRAUBUNG
RACCORD EQUERRE
RACOR A L INTERMEDIO
CONEXÃO EM "L" TUBO-TUBO

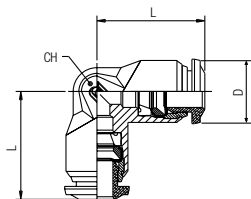

Code	Tube	L	CH	D	Pack.
50130 00 N07	3	17	9	10	10
50130 00 N01	4	17	9	10	10
50130 00 N06	5	20	11	12.5	10
50130 00 N02	6	21	11	12.5	10
50130 00 N03	8	22.5	13	14	10
50130 00 N04	10	26.5	16	17	10
50130 00 N05	12	30.5	19	21.5	10
50130 00 N08	14	32.5	19	21.5	10

50200N

RACCORDO A T MASCHIO CONICO

TEE MALE ADAPTOR (TAPER) - CENTRE LEG
T-EINSCHRAUBVERSCHRAUBUNG KONISCH (NICHT DREHBAR)
TÉ NON ORIENTABLE À PIQUAGE MÂLE CENTRAL, CONIQUE
RACOR A T MACHO CENTRAL CÓNICO
CONEXÃO EM "T" CENTRAL COM ROSCA MACHO CÔNICA

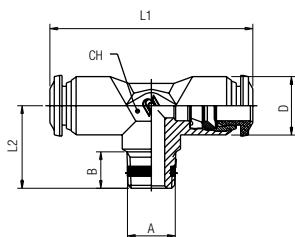

Code	Tube	A	B	L1	L2	CH	D	Pack.
50200 00 N01	4	M5	5	34	15	9	10	10
50200 00 N02	4	1/8	7.5	34	15.5	9	10	10
50200 00 N10	5	1/8	7.5	40	17.5	11	12.5	10
50200 00 N03	6	1/8	7.5	42	17.5	11	12.5	10
50200 00 N04	8	1/8	7.5	45	19	13	14	10
50200 00 N05	8	1/4	11	45	21.5	13	14	10
50200 00 N06	10	1/4	11	53	24.5	16	17	10
50200 00 N07	10	3/8	11.5	53	24	16	17	10
50200 00 N08	12	1/4	11	61	28	19	21.5	10
50200 00 N09	12	3/8	11.5	61	28	19	21.5	10

50211N

RACCORDO A T ORIENTABILE MASCHIO "UNIVERSAL SHORT"

ORIENTING TEE MALE ADAPTOR "UNIVERSAL SHORT" - CENTRE LEG
T-EINSCHRAUBVERSCHRAUBUNG KONISCH (DREHBAR) "UNIVERSAL SHORT"
TÉ ORIENTABLE À PIQUAGE MÂLE CENTRAL, CONIQUE "UNIVERSAL SHORT"
RACOR A T ORIENTABLE MACHO CENTRAL CÓNICO "UNIVERSAL SHORT"
CONEXÃO EM "T" CENTRAL ORIENTÁVEL COM ROSCA MACHO "UNIVERSAL SHORT"

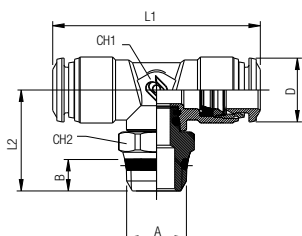

Code	Tube	A	B	L1	L2	CH1	CH2	D	Pack.
50211 00 N01	4	1/8	5.5	34	20	9	13	10	10
50211 00 N02	4	1/4	7	34	21.5	9	15	10	10
50211 00 N03	5	1/8	5.5	40	22	11	13	12.5	10
50211 00 N04	6	1/8	5.5	42	22	11	13	12.5	10
50211 00 N05	6	1/4	7	42	23.5	11	15	12.5	10
50211 00 N06	8	1/8	5.5	45	25.5	13	13	14.5	10
50211 00 N07	8	1/4	7	45	25.5	13	15	14.5	10
50211 00 N08	8	3/8	7.5	45	26	13	17	14.5	10
50211 00 N09	8	1/2	9	45	28.5	13	21	14.5	10
50211 00 N10	10	1/4	7	53	29	14	16	17.5	10
50211 00 N11	10	3/8	7.5	53	27	14	17	17.5	10
50211 00 N12	10	1/2	9	53	29.5	14	21	17.5	10
50211 00 N13	12	3/8	7.5	62.6	29.5	16	20	21.5	10
50211 00 N14	12	1/2	9	62.6	32	16	21	21.5	10
50211 00 N15	14	3/8	7.5	62.6	29.5	16	20	21.5	10
50211 00 N16	14	1/2	9	62.6	32	16	21	21.5	10

50216N

RACCORDO A T ORIENTABILE MASCHIO CILINDRICO

ORIENTING TEE MALE ADAPTOR (PARALLEL) - CENTRE LEG
 T-EINSCHRAUBVERSCHRAUBUNG ZYLINDRISCH (DREHBAR)
 TÉ ORIENTABLE À PIQUAGE MÂLE CENTRAL, CYLINDRIQUE
 RACOR A T ORIENTABLE MACHO CENTRAL CILÍNDRICO CON TÓRICA
 CONEXÃO EM "T" CENTRAL ORIENTÁVEL COM ROSCA MACHO PARALELA

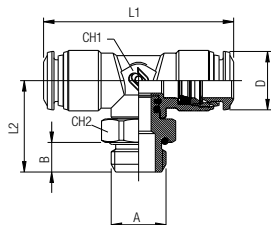

Code	Tube	A	B	L1	L2	CH1	CH2	D	Pack.
50216 00 N01	3	M5	3.5	33	17	9	8	10	10
50216 00 N02	4	M5	3.5	34	18	9	8	10	10
50216 00 N03	4	1/8	5.5	34	18.5	9	13	10	10
50216 00 N04	4	1/4	7	34	20	9	16	10	10
50216 00 N05	5	M5	3.5	40	20.5	11	11	12.5	10
50216 00 N06	5	1/8	5.5	40	20.5	11	13	12.5	10
50216 00 N07	6	M5	3.5	42	20.5	11	11	12.5	10
50216 00 N08	6	1/8	5.5	42	20.5	11	13	12.5	10
50216 00 N09	6	1/4	7	42	22	11	16	12.5	10
50216 00 N10	8	1/8	5.5	45	23.5	13	13	14.5	10
50216 00 N11	8	1/4	7	45	24	13	16	14.5	10
50216 00 N12	8	3/8	8	45	26	13	20	14.5	10
50216 00 N13	8	1/2	9.5	45	27.5	13	25	14.5	10
50216 00 N14	10	1/4	7	53	27.5	14	16	17.5	10
50216 00 N15	10	3/8	8	53	27	14	20	17.5	10
50216 00 N16	10	1/2	9.5	53	28.5	14	25	17.5	10
50216 00 N17	12	3/8	8	62.5	29.5	16	20	21.5	10
50216 00 N18	12	1/2	9.5	62.5	31	16	25	21.5	10
50216 00 N19	14	3/8	8	62.5	29.5	16	20	21.5	10
50216 00 N20	14	1/2	9.5	62.5	31	16	25	21.5	10
50216 00 N21	6	M12x1	7.5	42	22	11	16	12.5	10
50216 00 N22	6	M12x1.25	7.5	42	22	11	16	12.5	10
50216 00 N23	6	M12x1.5	7.5	42	22	11	16	12.5	10

50223N

RACCORDO A T ORIENTABILE MASCHIO LATERALE "UNIVERSAL SHORT"

ORIENTING TEE MALE ADAPTOR "UNIVERSAL SHORT" OFF - SET LEG
 L-EINSCHRAUBVERSCHRAUBUNG KONISCH (DREHBAR) "UNIVERSAL SHORT"
 TÉ ORIENTABLE À PIQUAGE LATÉRAL, CONIQUE "UNIVERSAL SHORT"
 RACOR A T ORIENTABLE MACHO LATERAL CÓNICO "UNIVERSAL SHORT"
 CONEXÃO EM "T" LATERAL ORIENTÁVEL COM ROSCA MACHO "UNIVERSAL SHORT"

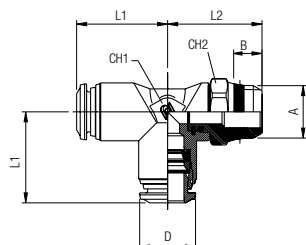

Code	Tube	A	B	L1	L2	CH1	CH2	D	Pack.
50223 00 N01	4	1/8	5.5	17	20	9	13	10	10
50223 00 N02	4	1/4	7	17	21.5	9	15	10	10
50223 00 N03	5	1/8	5.5	20	22	11	13	12.5	10
50223 00 N04	6	1/8	5.5	21	22	11	13	12.5	10
50223 00 N05	6	1/4	7	21	23.5	11	15	12.5	10
50223 00 N06	8	1/8	5.5	22.5	25	13	13	14.5	10
50223 00 N07	8	1/4	7	22.5	25	13	15	14.5	10
50223 00 N08	8	3/8	7.5	22.5	28	13	17	14.5	10
50223 00 N09	8	1/2	9	22.5	28	13	21	14.5	10
50223 00 N10	10	1/4	7	26.5	26	14	16	17.5	10
50223 00 N11	10	3/8	7.5	26.5	26	14	17	17.5	10
50223 00 N12	10	1/2	9	26.5	28.5	14	21	17.5	10
50223 00 N13	12	3/8	7.5	31.5	29.5	16	20	21.5	10
50223 00 N14	12	1/2	9	31.5	32	16	21	21.5	10

50226N

RACCORDO A T ORIENTABILE MASCHIO LATERALE CILINDRICO

ORIENTING TEE MALE ADAPTOR (PARALLEL) OFF - SET LEG
 L-EINSCHRAUBVERSCHRAUBUNG ZYLINDRISCH (DREHBAR)
 TÉ ORIENTABLE À PIQUAGE LATÉRAL, CYLINDRIQUE
 RACOR A T ORIENTABLE MACHO LATERAL CILÍNDRICO CON TÓRICA
 CONEXÃO EM "T" LATERAL ORIENTÁVEL COM ROSCA MACHO PARALELA

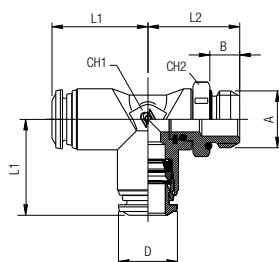

Code	Tube	A	B	L1	L2	CH1	CH2	D	Pack.
50226 00 N01	3	M5	3.5	16.5	17	9	8	10	10
50226 00 N02	4	M5	3.5	17	18	9	8	10	10
50226 00 N03	4	1/8	5.5	17	18.5	9	13	10	10
50226 00 N04	4	1/4	7	17	20	9	16	10	10
50226 00 N05	5	M5	3.5	20	20.5	11	11	12.5	10
50226 00 N06	5	1/8	5.5	20	20.5	11	13	12.5	10
50226 00 N07	6	M5	3.5	21	20.5	11	11	12.5	10
50226 00 N08	6	1/8	5.5	21	20.5	11	13	12.5	10
50226 00 N09	6	1/4	7	21	22	11	16	12.5	10
50226 00 N10	8	1/8	5.5	22.5	22.5	13	13	14.5	10
50226 00 N11	8	1/4	7	22.5	24	13	16	14.5	10
50226 00 N12	8	3/8	8	22.5	26	13	20	14.5	10
50226 00 N13	8	1/2	9.5	22.5	27.5	13	25	14.5	10
50226 00 N14	10	1/4	7	26.5	27	14	16	17.5	10
50226 00 N15	10	3/8	8	26.5	26.5	14	20	17.5	10
50226 00 N16	10	1/2	9.5	26.5	28	14	25	17.5	10
50226 00 N17	12	3/8	8	31.5	29.5	16	20	21.5	10
50226 00 N18	12	1/2	9.5	31.5	31	16	25	21.5	10
50226 00 N21	6	M12x1	7.5	21	22	11	16	12.5	10
50226 00 N22	6	M12x1.25	7.5	21	22	11	16	12.5	10
50226 00 N23	6	M12x1.5	7.5	21	22	11	16	12.5	10

50230N

RACCORDO A T INTERMEDIO

TEE CONNECTOR
T-ANSCHLUSS
RACCORD TÉ
RACOR A T INTERMEDIO
CONEXÃO EM "T" TUBO-TUBO

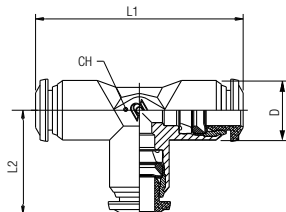

Code	Tube	L1	L2	CH	D	Pack.
50230 00 N07	3	34	17	9	10	10
50230 00 N01	4	34	17	9	10	10
50230 00 N06	5	40	20	11	12.5	10
50230 00 N02	6	42	21	11	12.5	10
50230 00 N03	8	45	22.5	13	14	10
50230 00 N04	10	53	26.5	16	17	10
50230 00 N05	12	61	30.5	19	21.5	10
50230 00 N08	14	65.5	32.5	19	21.5	10

50310N

RACCORDO A Y INTERMEDIO

Y CONNECTOR
Y-ANSCHLUSS
RACCORD Y SIMPLE
RACOR A Y INTERMEDIO
CONEXÃO EM "Y" TUBO-TUBO

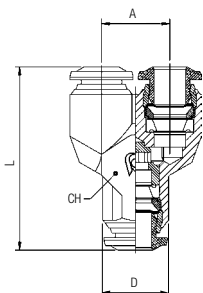

Code	Tube	A	L	CH	D	Pack.
50310 00 N07	3	10	29	11	10	10
50310 00 N01	4	11	32	11	10	10
50310 00 N04	5	13.5	35	13	12.5	10
50310 00 N02	6	13.5	36.5	13	12.5	10
50310 00 N03	8	15.5	41	15	14	10
50310 00 N08	10	18.5	48	18	17	10

50500N

ANELLO ORIENTABILE A L

SINGLE BANJO BODY
RINGANSCHLUSS
CORPS SIMPLE POUR BANJO
ANILLO ORIENTABLE SIMPLE
ANEL ORIENTÁVEL EM "L"

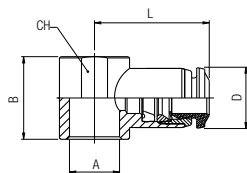

Code	Tube	A	B	L	CH	D	Pack.
50500 00 N19	3	M5	12.5	19	-	10	10
50500 00 N20	3	M6	12.5	19	-	10	10
50500 00 N01	4	M5	12.5	19	-	10	10
50500 00 N02	4	M6	12.5	19	-	10	10
50500 00 N03	4	1/8	15	21	14	10	10
50500 00 N13	5	M5	12.5	20	-	12.5	10
50500 00 N17	5	M6	12.5	20	-	12.5	10
50500 00 N14	5	1/8	15	21.5	14	12.5	10
50500 00 N15	5	1/4	17	24.5	18	12.5	10
50500 00 N16	6	M5	12.5	20.5	-	12.5	10
50500 00 N18	6	M6	12.5	20.5	-	12.5	10
50500 00 N04	6	1/8	15	22	14	12.5	10
50500 00 N05	6	1/4	17	25	18	12.5	10
50500 00 N06	8	1/8	15	24	14	14	10
50500 00 N07	8	1/4	17	26	18	14	10
50500 00 N08	8	3/8	20	28	21	14	10
50500 00 N09	10	1/4	17	29	18	17	10
50500 00 N10	10	3/8	20	30.5	21	17	10
50500 00 N12	12	3/8	20	32.5	21	21.5	10
50500 00 N21	12	1/2	24	35	25	21.5	10
50500 00 N22	14	1/2	24	35.5	25	21.5	10

50510N

ANELLO ORIENTABILE A T

DOUBLE BANJO BODY
DOPPELTER RINGANSCHLUSS
CORPS DOUBLE POUR BANJO
ANILLO ORIENTABLE DOBLE
ANEL ORIENTÁVEL EM "T"

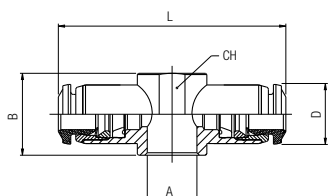

Code	Tube	A	B	L	CH	D	Pack.
50510 00 N01	4	M5	12.5	38	-	10	10
50510 00 N02	4	M6	12.5	38	-	10	10
50510 00 N03	4	1/8	15	42	14	10	10
50510 00 N08	5	1/8	15	43	14	12.5	10
50510 00 N09	5	1/4	17	49	18	12.5	10
50510 00 N04	6	1/8	15	44	14	12.5	10
50510 00 N05	6	1/4	17	50	18	12.5	10
50510 00 N06	8	1/8	15	48	14	14	10
50510 00 N07	8	1/4	17	52	18	14	10

50550N

RACCORDO ORIENTABILE A L

ORIENTING SINGLE BANJO BODY MALE
 WINKELSCHWENKVERSCHRAUBUNG (DREHBAR)
 EQUERRE BANJO MÂLE, ORIENTABLE
 RACOR ORIENTABLE SIMPLE CON TÓRICA
 CONEXÃO TIPO BANJO EM "L"

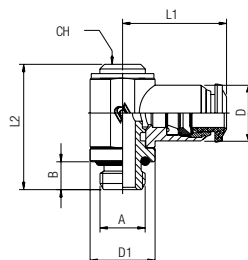

Code	Tube	A	B	L1	L2	CH	D1	D	Pack.
50550 00 N01	4	M5	3.6	19	24.5	-	CH8	10	10
50550 00 N02	4	1/8	6	21	28	5	14	10	10
50550 00 N12	5	M5	3.6	20	24.5	-	CH8	12.5	10
50550 00 N13	5	1/8	6	21.5	28	5	14	12.5	10
50550 00 N14	5	1/4	8	24.5	31	6	17	12.5	10
50550 00 N15	6	M5	3.6	20.5	24.5	-	CH8	12.5	10
50550 00 N03	6	1/8	6	22.5	28	5	14	12.5	10
50550 00 N04	6	1/4	8	25	31	6	17	12.5	10
50550 00 N05	8	1/8	6	24	28	5	14	14	10
50550 00 N06	8	1/4	8	26	31	6	17	14	10
50550 00 N07	8	3/8	9	28	35.5	7	20	14	10
50550 00 N08	10	1/4	8	29	31	6	17	17	10
50550 00 N09	10	3/8	9	30.5	35.5	7	20	17	10
50550 00 N11	12	3/8	9	32.5	35.5	7	20	21.5	10

50560N

RACCORDO ORIENTABILE A T

ORIENTING DOUBLE BANJO BODY MALE
 T-SCHWENKVERSCHRAUBUNG (DREHBAR)
 TÊ BANJO MÂLE, ORIENTABLE
 RACOR ORIENTABLE DOBLE CON TÓRICA
 CONEXÃO TIPO BANJO EM "T"

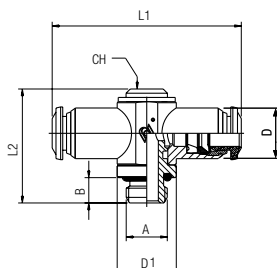

Code	Tube	A	B	L1	L2	D1	CH	D	Pack.
50560 00 N02	4	1/8	6	42	27	14	5	10	10
50560 00 N08	5	1/8	6	43	27	14	5	12.5	10
50560 00 N09	5	1/4	8	49	31	17	6	12.5	10
50560 00 N03	6	1/8	6	45	27	14	5	12.5	10
50560 00 N04	6	1/4	8	50	31	17	6	12.5	10
50560 00 N05	8	1/8	6	48	27	14	5	14	10
50560 00 N06	8	1/4	8	52	31	17	6	14	10

51410

VITE CAVA SINGOLA

BANJO STEM SINGLE
 EINFACHE HOHLSCHRAUBE
 VIS POUR BANJO SIMPLE
 TORNILLO SIMPLE
 HASTE PARA CONEXÃO BANJO COM 1 CAVIDADE

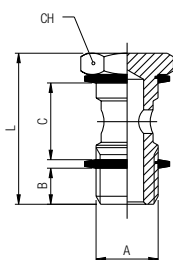

Code	A	B	C	L	CH	Pack.
51410 00 011	M5	4	12.5	22	8	10
51410 00 012	M6	5	12.5	23	8	10
51410 00 013	1/8	6	15	28	14	10
51410 00 014	1/4	8	17	32	17	10
51410 00 015	3/8	9	20	36	19	10
51410 00 016	1/2	10	24	42	24	10
51410 00 017	*M12x1.5	8	17	32	17	10

Questo articolo viene fornito completo di rondelle in PA66 (ART. 1610).
 This item will be supplied with the PA66 washers (ART. 1610).
 Dieser artikel wird mit dichtringen aus PA66 (ART. 1610) mitgeliefert.
 Livré avec joints en PA66 (ART. 1610).
 Este artículo viene completo de arandelas en nylon (ART. 1610).
 Este item vem acompanhado de arruelas em PA66 (CÓD. 1610).

- * Con questa vite utilizzare gli anelli orientabili da 1/4.
- * With this banjo stem using 1/4 orienting banjo body.
- * Bei dieser größe können dichtringe für 1/4 eingesetzt werden.
- * Compatible avec joint 1/4.
- * Con este tornillo utilizar el anillo orientable de 1/4.
- * Com esta haste para banjo utilizar os anéis orientáveis de 1/4.

51420

VITE CAVA DOPPIA

BANJO STEM DOUBLE
DOPPELTE HOHLSCHRAUBE
VIS POUR BANJO DOUBLE
TORNILLO DOBLE
HASTE PARA CONEXÃO BANJO COM 2 CAVIDADES

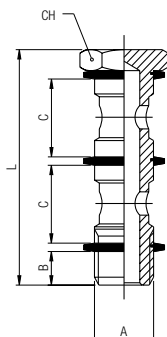

Code	A	B	C	L	CH	Pack.
51420 00 011	1/8	6	15	44.5	14	10
51420 00 012	1/4	8	17	50.5	17	10
51420 00 013	3/8	9	20	58	19	10
51420 00 014	1/2	10	24	68	24	10
51420 00 015	*M12x1.5	8	17	50.5	17	10

Questo articolo viene fornito completo di rondelle in PA66 (ART. 1610).

This item will be supplied with the PA66 washers (ART. 1610).

Dieser artikel wird mit dichtringen aus PA66 (ART. 1610) Mitgeliefert.

Livré avec joints en PA66 (ART. 1610).

Este artículo viene completo de arandelas en nylon (ART. 1610).

Este item vem acompanhado de arruelas em PA66 (CÓD. 1610).

* Con questa vite utilizzare gli anelli orientabili da 1/4.

* With this banjo stem using 1/4 orienting banjo body.

* Bei dieser größe können dichtringe für 1/4 eingesetzt werden.

* Compatible avec joint 1/4.

* Con este tornillo utilizar el anillo orientable de 1/4.

* Com esta haste para banjo utilizar os anéis orientáveis de 1/4.

51430

VITE CAVA TRIPLA

BANJO STEM TRIPLE
DREIFACH HOHLSCHRAUBE
VIS POUR BANJO TRIPLE
TORNILLO TRIPLE
HASTE PARA CONEXÃO BANJO COM 3 CAVIDADES

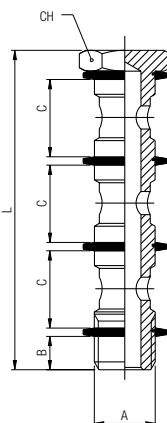

Code	A	B	C	L	CH	Pack.
51430 00 011	1/8	6	15	61	14	10
51430 00 012	1/4	8	17	69	17	10
51430 00 013	3/8	9	20	80	19	10
51430 00 014	1/2	10	24	94	24	10

Questo articolo viene fornito completo di rondelle in PA66 (ART. 1610).

This item will be supplied with the PA66 washers (ART. 1610).

Dieser artikel wird mit dichtringen aus PA66 (ART. 1610) Mitgeliefert.

Livré avec joints en PA66 (ART. 1610).

Este artículo viene completo de arandelas en nylon (ART. 1610).

Este item vem acompanhado de arruelas em PA66 (cód. 1610).

51440

VITE CAVA SINGOLA MASCHIO - FEMMINA

MALE - FEMALE BANJO STEM SINGLE
AUFSCHRAUBHOHLSCHRAUBE MIT INNENGEWINDE
VIS CREUSE TARAUDÉE POUR BANJO SIMPLE
TORNILLO SIMPLE MACHO - HEMBRA
HASTE PARA CONEXÃO BANJO COM 1 CAVIDADE MACHO - FÊMEA

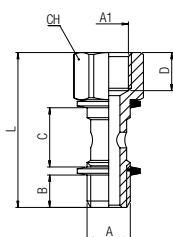

Code	A	A1	B	C	D	L	CH	Pack.
51440 00 001	1/8	1/8	6	15	8.5	34.5	14	10
51440 00 002	1/4	1/4	8	17	11	40.5	17	10
51440 00 003	3/8	3/8	9	20	12	45.5	19	10

Questo articolo viene fornito completo di rondelle in PA66 (ART. 1610).

This item will be supplied with the PA66 washers (ART. 1610).

Dieser artikel wird mit dichtringen aus PA66 (ART. 1610) Mitgeliefert.

Livré avec joints en PA66 (ART. 1610).

Este artículo viene completo de arandelas en nylon (ART. 1610).

Este item vem acompanhado de arruelas em PA66 (CÓD. 1610).

50600

ADATTATORE MASCHIO CILINDRICO

MALE ADAPTOR PARALLEL
EINSCHRAUBSTECKVERSCHRAUBUNG ZYLINDRISCH
ADAPTATEUR ENCLIQUETABLE MÂLE, CYLINDRIQUE
ADAPTADOR MACHO CILÍNDRICO CON TÓRICA
ADAPTADOR MACHO COM ROSCA PARALELA

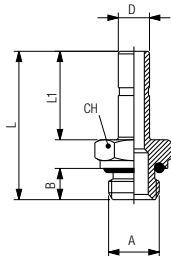

Code	D	A	B	L	L1	CH	Pack.
50600 00 001	4	M5	4	24	15	8	10
50600 00 002	4	1/8	6	26.5	15	13	10
50600 00 012	5	M5	4	26	17	8	10
50600 00 013	5	1/8	6	28.5	17	13	10
50600 00 014	5	1/4	8	31	17	16	10
50600 00 015	6	M5	4	26	17	8	10
50600 00 003	6	1/8	6	28.5	17	13	10
50600 00 004	6	1/4	8	31	17	16	10
50600 00 005	8	1/8	6	29.5	18	13	10
50600 00 006	8	1/4	8	32	18	16	10
50600 00 007	8	3/8	9	33.5	18	20	10
50600 00 016	10	1/8	6	33.5	22	13	10
50600 00 008	10	1/4	8	36	22	16	10
50600 00 009	10	3/8	9	37.5	22	20	10
50600 00 010	12	1/4	8	38.5	24.5	16	10
50600 00 011	12	3/8	9	40	24.5	20	10
50600 00 018	14	1/2	10	44	26.5	24	10

50610

TAPPO IN POLIAMIDE

POLYAMIDE PLUG
VERSCHLUSSZAPFEN POLYAMID
BOUCHON EN POLYAMIDE
TAPÓN EN POLIAMIDA
TAMPÃO EM POLIAMIDA

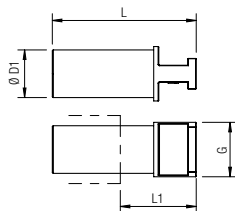

Code	ØD1	G	L	L1	Pack.
50610 00 31 X0 RO	3	5	30.5	18	10
50610 00 31 X1 RO	4	6	29.5	15.5	10
50610 00 31 X3 RO	5	7	33.5	18	10
50610 00 31 X4 RO	6	8	32	15.5	10
50610 00 31 X7 RO	8	10	35.5	19.5	10
50610 00 31 X9 RO	10	12	40	19.5	10
50610 00 31 Y1 RO	12	14	41.5	20	10
50610 00 31 Y3 RO	14	16	42	19.5	10

50625

GIUNZIONE DOPPIA

DOUBLE JOINT
DOPPELSTECKER
JONCTION DOUBLE
UNIÓN DOBLE
JUNÇÃO DUPLA



Code	Tube	L	Pack.
50625 00 01 X1 NB	4	31	10
50625 00 01 X3 NB	5	33	10
50625 00 01 X4 NB	6	34	10
50625 00 01 X7 NB	8	36	10
50625 00 01 X9 NB	10	45	10
50625 00 01 Y1 NB	12	50	10

50700N

RIDUZIONE

REDUCER
REDUZIERUNG
RÉDUCTION ENCLIQUETABLE
REDUCCIÓN
REDUÇÃO

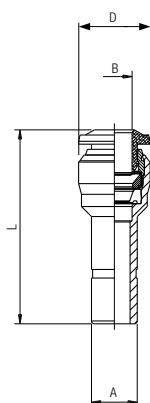

Code	A	B	L	D	Pack.
50700 00 N06	4	3	30	8.5	10
50700 00 N04	5	4	32	11.5	10
50700 00 N01	6	4	30	10.5	10
50700 00 N05	6	5	34.5	11.5	10
50700 00 N08	8	4	32.5	10.5	10
50700 00 N02	8	6	34.5	12.5	10
50700 00 N09	10	4	31.5	10.5	10
50700 00 N11	10	6	37.5	12.5	10
50700 00 N03	10	8	38.5	14.5	10
50700 00 N07	12	8	39.5	14.5	10
50700 00 N10	12	10	43	17.5	10

55800N

CARTUCCE A COMPRESSIONE

PUSH-FIT CARTRIDGES

EINPRESSPATRONEN

CARTOUCHE

CARTUCHO A COMPRESIÓN

CARTUCHO DE COMPRESSÃO

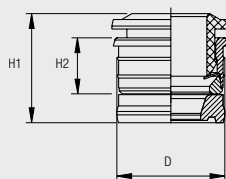

Code	Tube	D	H1	H2	Pack.
55800 00 N08	3	6.7	9	5	25
55800 00 N01	4	8.7	11	5.6	25
55800 00 N02	5	9.75	11.8	6.3	25
55800 00 N03	6	10.75	12.4	6.9	25
55800 00 N04	8	12.7	12.4	6.9	25
55800 00 N05	10	15.7	15.7	8.5	25
55800 00 N06	12	18.3	17.8	9.5	25

Dimensioni sedi cartucce a compressione.

Seats dimensions push-fit cartridges.

Bohrungsangaben für die einpresspatronen.

Dimensions des logements des cartouches.

Dimensiones sede cartucho a compresión.

Dimensão da sede do cartucho de compressão.

SEDE

SEAT

BOHRUNGEN

IMPLANTATION

SEDE

SEDE

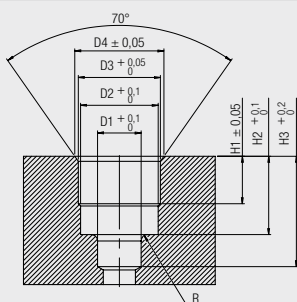

Tube	D1	D2	D3	D4	H1	H2	H3	R
3	3.4	6.05	6.4	6.95	3.7	6.1	8.6	0.5
4	4.2	7.45	8.4	9	3.75	6.5	9.5	0.5
5	5.2	8.35	9.4	10.15	4.45	7.9	10.5	0.5
6	6.2	9.35	10.45	11.35	5	8.5	11.5	0.5
8	8.2	11.4	12.4	12.9	5.2	8.5	12.5	0.75
10	10.2	14.5	15.4	16	6.7	10.5	15	0.75
12	12.2	17	18	19	7.5	12.1	17	1

55801

FRESA SEDE CARTUCCE A COMPRESSIONE

TOOL FOR PUSH-FIT CARTRIDGES SEAT

STUFENBOHRER FÜR EINPRESSPATRONEN

OUTIL DE PERÇAGE POUR CARTOUCHE

FRESA SEDE CARTUCHO A COMPRESIÓN

FRESA PARA FURAÇÃO DA SEDE DO CARTUCHO DE COMPRESSÃO



Code	Tube	ø Body	Pack.
55801 00 007	3	10	1
55801 00 001	4	10	1
55801 00 006	5	12	1
55801 00 002	6	12	1
55801 00 003	8	12	1
55801 00 004	10	16	1
55801 00 005	12	16	1

55802

CANOTTO MONTAGGIO CARTUCCE A COMPRESSIONE

ASSEMBLING TOOL FOR PUSH-FIT CARTRIDGES

MONTAGEWERKZEUG FÜR EINPRESSPATRONEN

OUTIL DE MONTAGE POUR CARTOUCHE

ÚTIL DE MONTAJE CARTUCHO A COMPRESIÓN

TUBETE PARA MONTAGEM DO CARTUCHO DE COMPRESSÃO



Code	Tube	Pack.
55802 00 001	3	1
55802 00 002	4	1
55802 00 003	5	1
55802 00 004	6	1
55802 00 005	8	1
55802 00 006	10	1
55802 00 007	12	1

ISTRUZIONI DI MONTAGGIO CARTUCCE A COMPRESIONE ART. 55800
 PUSH-FIT CARTRIDGES ASSEMBLING INSTRUCTIONS ART. 55800
 ANLEITUNG FÜR DIE MONTAGE DER EINPRESSPATRONEN ART. 55800
 INSTRUCTIONS DE MONTAGE POUR CARTOUCHE RÉF. 55800
 INSTRUCCIONES DE MONTAJE CARTUCHO A COMPRESIÓN ART. 55800
 INSTRUÇÕES DE MONTAGEM DO CARTUCHO DE COMPRESSÃO CÓD. 55800

1

Realizzare la sede per la cartuccia utilizzando l'apposita fresa Art. 55801.

Make the seat for the cartridge utilizing the suitable tool Art. 55801.

Machen sie die Sitze für die Einpresspatronen mit dem entsprechenden Stufenbohrer Art. 55801.

Usiner le logement de la cartouche à l'aide de l'outil de perçage réf. 55801.

Realizar la sede para el cartucho utilizando la correspondiente fresa Art. 55801.

Realize a furação da sede para o cartucho utilizando a fresa de cód. 55801.



2

Inserire la guarnizione a labbro nell'apposita sede.

Insert the lip seal inside of the seat.

Legen sie die Lippen-dichtung in die Bohrung ein.

Insérer le joint à lèvres dans le logement.

Insertar la junta de labio en la correspondiente sede.

Insira vedação no fundo da sede.



3

Inserire la cartuccia nel canotto di montaggio Art. 55802.

Insert the cartridge into the assembling tool Art. 55802.

Legen sie die Einpresspatrone in das Montage-werkzeug Art. 55802.

Insérer la cartouche dans l'outil de montage réf. 55802.

Insertar el cartucho en el útil de montaje Art. 55802.

Insira o cartucho no tubete de montagem Cód. 55802.



4

Premere la cartuccia all'interno della sede fino ad arrivare in battuta sul piano con il canotto.

Press the cartridge inside of the seat until it will be reached the abutment surface with the assembling tool.

Drücken sie die Einpresspatrone in die Bohrung, bis das Montagewerkzeug am Werkstück ansteht.

Presser la cartouche dans le logement jusqu'à ce que l'outil de montage soit en contact avec la surface.

Empujar el cartucho al interior de la sede hasta llegar al plano con el útil de montaje.

Pressione o cartucho no interior da sede até tocar a superfície de montagem com o tubete.



50900N

RIPARTITORE IN ALLUMINIO A 5 VIE

ALUMINIUM MANIFOLD 5 WAYS

ALUMINIUM-VERTEILER MIT 5 AUSGÄNGEN

BLOQUE DE DISTRIBUTION EN ALUMINIUM (5 SORTIES)

REGLETA EN ALUMINIO A 5 VIAS

DISTRIBUIDOR EM ALUMÍNIO DE 5 VIAS

Code	Tube	A	H	F	C	S	D	L	L1	L2	Pack.
50900 00 N01	4	1/8	66	5	15	4.5	25	75	12	13.5	5
50900 00 N02	6	1/8	80	5	15	4.5	25	90	14.5	16	5
50900 00 N03	6	1/4	80	5	20	4.5	30	90	14.5	16	5
50900 00 N04	8	1/4	90	5	20	4.5	30	100	16	18	5

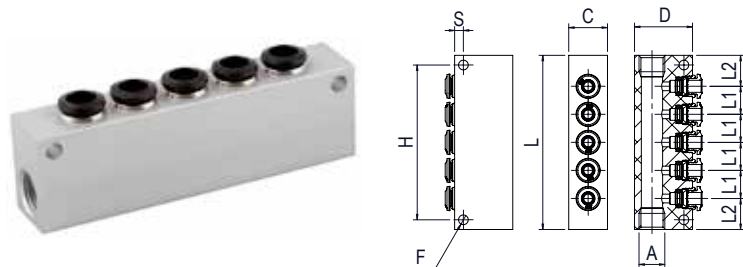

50980

CLIP DI SICUREZZA

SECURITY CLIPS

SICHERHEITSCLIP

CLIP DE SECURITÉ

CLIP DE SEGURIDAD ROJO

CLIP DE SEGURANÇA

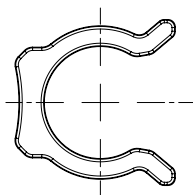

Code	Tube	Pack.
50980 00 32 X1 RO	4-(5/32)	50
50980 00 32 X3 RO	5	50
50980 00 32 X4 RO	6-(1/4)	50
50980 00 32 X7 RO	8-(5/16)	50
50980 00 32 X9 RO	10-(3/8)	50
50980 00 32 Y1 RO	12-(1/2)	50
50980 00 32 Y3 RO	14	50

50990

LEVA SGANCIO ADATTATORI

TOOL FOR DISASSEMBLING

LÖSEWERKZEUG

OUTIL DE DÉMONTAGE

LLAVE DE DESMONTAJE

FERRAMENTA PARA DESMONTAGEM

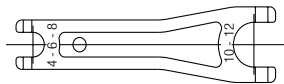

Code	Pack.
50990 00 001	10

50006

ANELLO DI TENUTA PER FILETTI CONICI "UNIVERSAL SHORT"

THREAD PACKING FOR THE "UNIVERSAL SHORT" TAPER THREADS

DICHTRINGE FÜR KONISCHE GEWINDE "UNIVERSAL SHORT"

BAGUE D'ÉTANCHÉITÉ POUR FILETAGES CONIQUES "UNIVERSAL SHORT"

JUNTA DE CIERRE PARA ROSCAS CÓNICAS "UNIVERSAL SHORT"

ANEL DE VEDAÇÃO PARA ROSCAS CÔNICA "UNIVERSAL SHORT"

Code	Thread	Pack.
50006 00 24 02 00	1/8	10
50006 00 24 03 00	1/4	10
50006 00 24 04 00	3/8	10
50006 00 24 05 00	1/2	10

