

rotork®

Keeping the World Flowing
for Future Generations

IQ *Pro* range



IQ and IQT multi-turn and part-turn electric valve actuators

Reliability in critical flow control applications

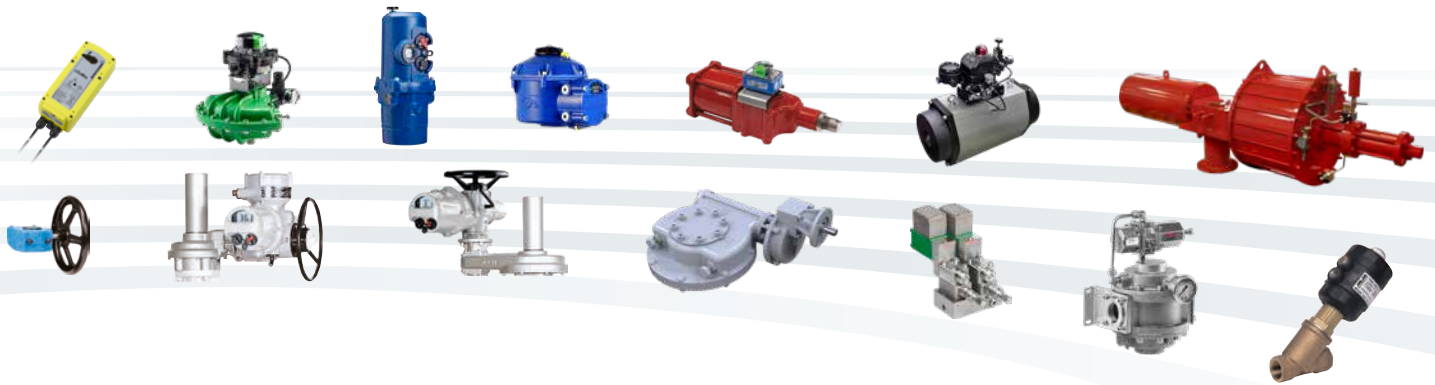

› Reliable operation when it matters

Assured reliability for critical applications and environments. Whether used infrequently or continuously, Rotork products will operate reliably and efficiently.

› Quality-driven global manufacturing

We offer products that have been designed with over 60 years of industry and application knowledge.

Our research and development ensures cutting edge products are available for multiple applications across multiple industries.

› Customer focused service and worldwide support

Rotork solve customer challenges and develop new solutions that are tailored to the needs of our clients.

We offer dedicated, expert service and support from initial inquiry, to product installation, to long-term after sales care.

› Low cost of ownership

Long-term reliability prolongs service life.

Rotork helps to reduce long-term cost of ownership and provides greater efficiency to process and plant.

IQ Pro range

Section	Page	Section	Page
IQ multi-turn actuators	4	Multiple bus connectivity	16
IQT part-turn actuators	5	Actuator specification	19
<i>Pro</i> features	6	Performance summaries	20
Advanced engineering	8	Actuator drive couplings	24
Design features	10	Standard specifications	26
Rotork Pakscan and Rotork <i>Master Station</i>	14	Rotork Site Services	46
Rotork <i>Master Station</i> - network capabilities	15		



Comprehensive product range serving multiple industries

Rotork products offer improved efficiency, assured safety and environmental protection across sectors such as the Power, Oil & Gas, Water & Wastewater, HVAC, Marine, Mining, Pulp & Paper, Food & Beverage, Pharmaceutical and Chemical sectors.

Market leaders and technical innovators

We have been the recognised market leader in flow control for over 60 years.

Our customers rely upon Rotork for innovative solutions to safely manage the flow of liquids, gases and powders.

Global presence, local service

We are a global company with local support.

Manufacturing sites, service centres and sales offices throughout the world provide unrivalled customer services, fast delivery and ongoing, accessible support.

Environmental Social and Governance is at the heart of our business

We have a range of policies in place that support our performance across environmental, social and governance topics. The majority of our policies are publicly available.



IQ multi-turn actuators



The IQ range

The Rotork IQ delivers a complete range of actuators suitable for all multi-turn valve applications requiring control and indication flexibility. It offers end users ever higher standards of performance, build quality and overall value.

Simple commissioning

The Rotork IQ provides simple, safe and rapid non-intrusive commissioning with infrared control. Actuator settings such as torque levels, position limits, control and indication functions can be accessed and adjusted using the "point and shoot" Actuator Setting Tool *Pro* BTST v1.1. This supplied tool is unique to Rotork and allows for non-intrusive actuator set-up whatever the environment, power on or off.

Simple troubleshooting

The large digital position display clearly indicates real time valve position from a distance. In addition, active valve, control, actuator status and alarm text messages are displayed on the easy to read back-lit display. Using the setting tool, real-time torque against position profiles and actuator configuration can be accessed during commissioning, adjustment or local valve performance monitoring. The on-board data logger records operational, alarm and valve torque profile data providing valuable information on valve and plant operating performance and conditions.

IQ offers a range of powerful features:

- 3-phase
- On-board data logger included as standard
- IrDA™ compatible for local and remote actuator analysis via Insight PC software
- Clear, user-friendly controls and indication
- Multilingual text display for status and setup
- Simplified torque and position control for increased reliability
- Comprehensive control and flexibility

IQ

IQ actuators are multi-turn electric actuators which can be used for isolation or regulating duties of up to 60 starts per hour. IQ's are watertight or water-tight and explosionproof depending upon specification.

Direct torque output range from 34 Nm (25 lbf.ft) to 3,000 Nm (2,200 lbf.ft).

IQM

The modulating version of the IQ has a solid state reversing starter in place of the electromechanical contactors. "Hammerblow" lost motion drive is removed and fast response remote control circuits for rapid control are included. The IQM is suitable for up to 1,200 starts per hour. The solid state starter also adds an electronic motor 'brake' feature, improving positional control.

Special designs

With our extensive product range and engineering knowledge Rotork can provide solutions for most applications.



IQT part-turn actuators

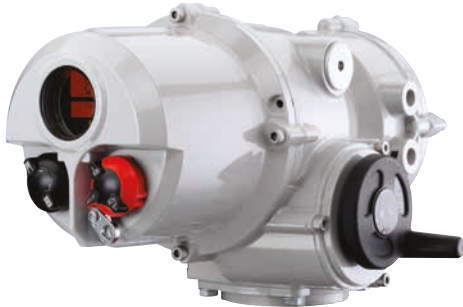

The IQT range

The IQT part-turn actuator is the result of ongoing commitment to product development at the cutting edge of new technology.

Maintaining the simple commissioning and troubleshooting design of the Rotork IQ (see left), the IQT is a direct drive, part-turn actuator, offering the highest standards in safety and control, with access to real time diagnostics and extensive bus compatibility.

IQT features:

- Direct drive part-turn
- 3-phase
- Multilingual text display for status and setup
- On-board data logger included as standard
- IrDA™ compatible for local and remote actuator analysis via Insight PC software
- Clear, user friendly controls and indication
- Simplified torque and position control for increased reliability
- Comprehensive control and flexibility

IQT

IQT actuators are direct drive part-turn electric actuators which can be used for isolation or regulating duties of up to 60 starts per hour. IQT's are watertight or explosionproof depending upon specification.

Torque output from 50 Nm (37 lbf.ft) to 2,000 Nm (1,476 lbf.ft).

IQTM

The modulating version of the IQT has solid state motor switching and includes fast response remote control circuits for rapid response to control signals. The IQTM is suitable for up to 1,200 starts per hour.

Special designs

With our extensive product range and engineering knowledge Rotork can provide solutions for all applications.

Pro

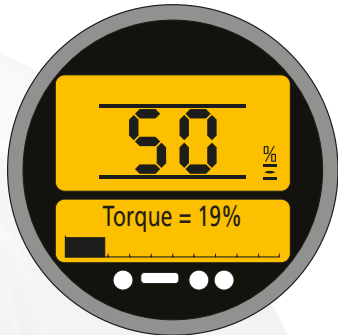

Torque and position monitoring



Realtime monitoring



Actuator alarms



Pro features

IQ Pro combines proven Rotork IQ features with additional control and indication functions, intelligent user interface design, performance monitoring and data logging - including valve torque signature profiles. This means unparalleled support in achieving reliable valve actuation.

The IQ Pro control system combines proven control logic with field programmable technology, thus providing increased functionality and reliability. IQ Pro control logic can be upgraded over the IrDA™ interface – this will “future proof” valve operation against control system and actuator developments and upgrades.

In combination with Rotork’s non-intrusive Actuator Setting Tool Pro BTST v1.1, IQ actuator set-up and data logger files can be transported from the field to the office for storage and analysis.

IQ and IQT Pro offer a range of powerful features unparalleled in valve actuation:

- Field upgradeable control system
- Large, clear display
- Customer configurable, multilingual text capability
- Data logger valve torque signature profiling
- Status and monitoring diagnostics
- Fast data download speed

Actuator Setting Tool Pro BTST v1.1 features include:

- Non-intrusive, Infrared communication
- On-site actuator configuration and data download
- Data transfer from actuator to PC with free Rotork Insight software
- Capacity for 10 configuration and 4 data logger files
- Multiple configuration capability

Actuator display

IQ *Pro* incorporates a unique liquid crystal display developed specifically for actuator indication. The unique, diffused LED backlighting system has a top section which indicates valve position and is operational over the full operating temperature range of the actuator. Large segments with backlighting allow clear visibility of valve position in all light conditions.

The lower section shows real time valve, control and actuator status, torque and alarm messaging during operation. Using the setting tool changes the display from position mode to set-up mode, allowing the user to view, adjust and change actuator settings.

The LCD display is supplemented with green, yellow and red position indication lights.

The display together with the control cover can be rotated through 90° increments to suit valve orientation and access.

Indication back up

Rotork recognise the need for local and remote position indication at all times, even when the actuator is powered down. The IQ incorporates a battery to maintain and update position indication when the main power is switched off. The battery also supports data logging and commissioning whilst power is off.

Set-up

Infrared set up, adjustment and review using the supplied, intrinsically safe setting tool gives users access to the configuration of the actuator.

Help screens

Eight help screens can be accessed with the setting tool, allowing real time, grouped analysis of control signal status, valve and actuator status and indication status.

Valve torque indication

Valve torque against position can be displayed in real time with a single setting tool keystroke. Trip levels set for torque switches can be checked and adjusted based on the actual valve operating torque requirements. This results in a more realistic and accurate set up, therefore reducing the need for future "snagging". Problems such as valve tight-spots, seating and breakout forces can be assessed immediately in the field.

Asset Management - data logging

IQ *Pro* allows complete actuator configuration and build information to be downloaded and saved to PC. It also includes a data logger that captures and stores valve, actuator and control system status information in non-volatile memory, including:

- **Valve torque profile** – open/closed instantaneous and average torque profiles plotted against valve stroke. Reference profiles stored during commissioning can be compared to in-service torque profiles for valve performance analysis.
- **Starts log** – open/closed start positions plotted against valve stroke. Allows process control valve operation.
- **Statistics** – number of operations, highest recorded torque, last limit switch operation, battery run time, battery voltage.
- **Monitor log** – Control system, actuator and indication event log. Can be replayed and filtered for events of interest such as "torque trip". The last 1024 events are stored and stamped with date and time.

Using the IQ *Pro* IrDA™ interface, data logger files can be downloaded to the Rotork setting tool or to a PDA running freeware IQ Pocket Insight for uploading to PC. IQ Insight PC based software is described in detail on page 12.



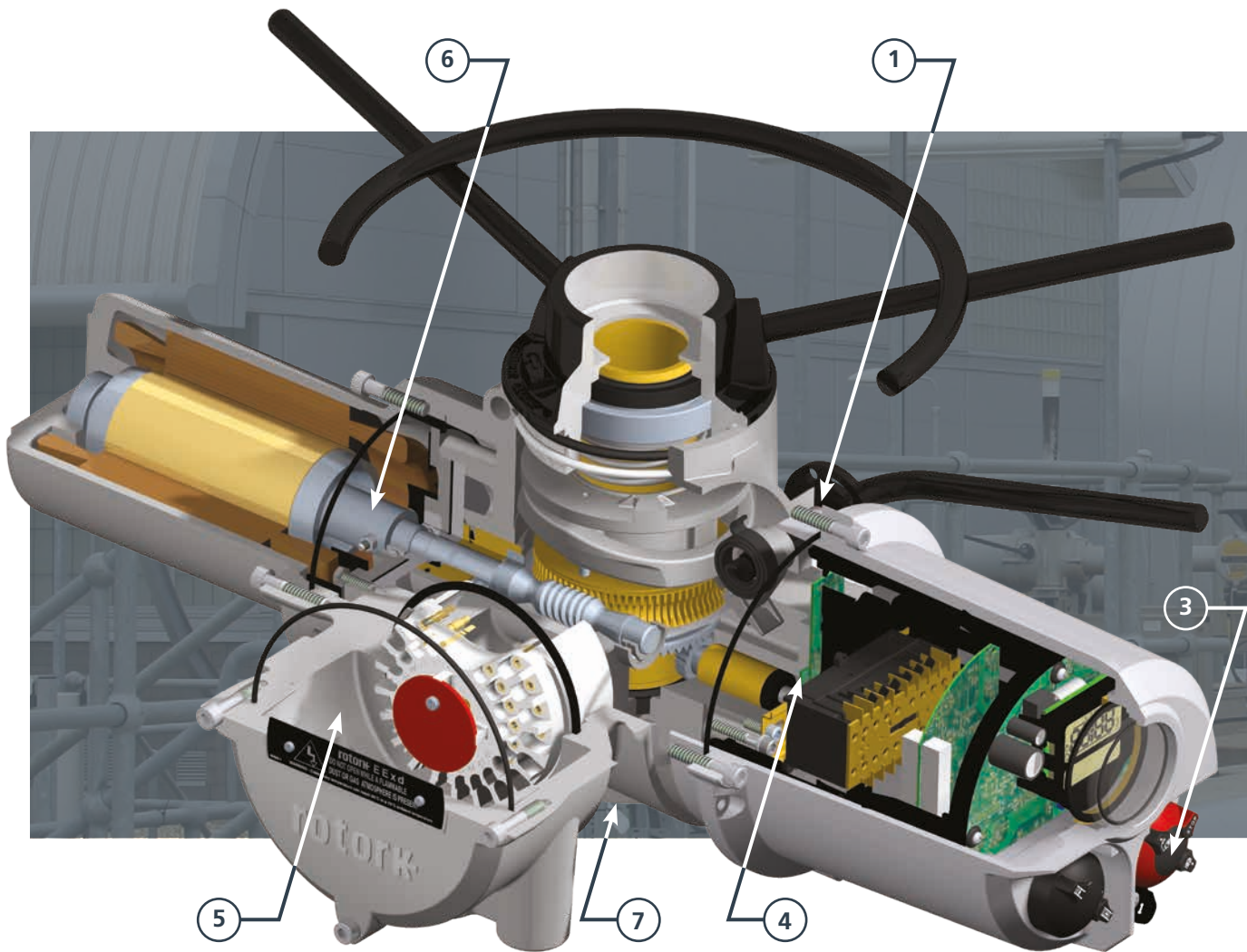

1 Hand operation

Direct drive handwheel (or geared handwheel on larger sizes and IQT) provides reliable emergency manual operation in the event of a power supply failure. Includes padlockable* hand/auto clutch for safe operation even when the motor is running.

Note: power operation always has preference unless hand/ auto lever is purposely locked into 'hand drive'. Lost motion 'hammerblow' effect is provided with both direct and independently geared handwheels.

2 Non-intrusive setting

All actuator settings and diagnostics are made through the sealed indication window using IrDA™ communication. It is not necessary to remove electrical covers which would expose the integral controls to the plant environment.

3 Local controls

Local controls and padlockable* Local/Stop/Remote selector switch operate internal reed switches, avoiding penetrating shafts which would have to be sealed to prevent moisture ingress.

4 Position control

Hall effect magnetic pulse system accurately measures and controls the stroke of the actuator without using gears and switches.

5 Terminal compartment

Separately sealed terminal compartment ensures the integrity of the electrical equipment even when the terminal cover is removed during on-site wiring.

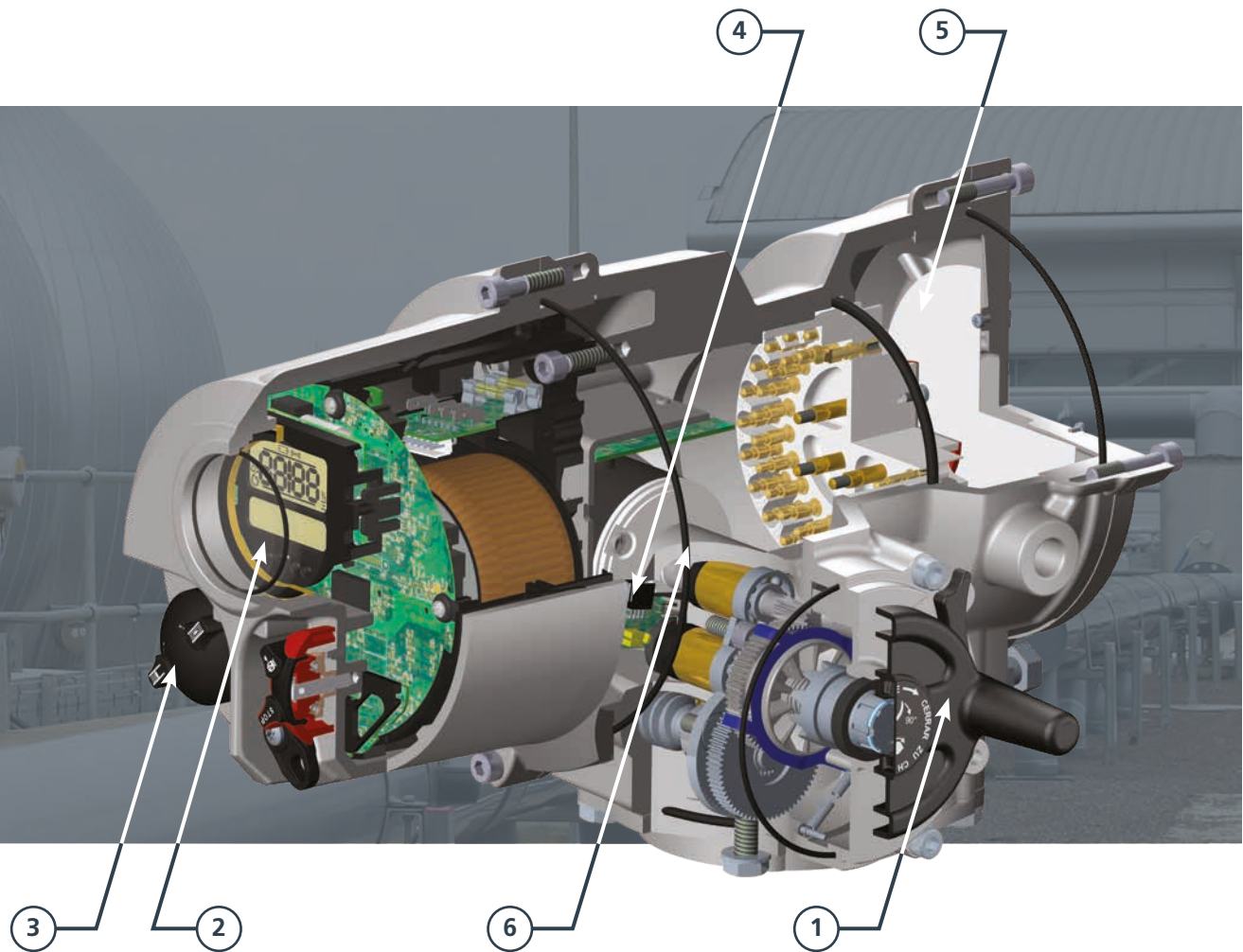

6 IQ motor and drive

The motor shaft and worm shaft separate to facilitate simple actuator speed change. The motor has low inertia and high torque. Peak torque is produced rapidly after starting but with very little overrun when de-energized.

The winding thermostat provides accurate temperature sensing, independent of ambient temperature conditions, to optimize the motor's thermal capacity. The motor drive includes a lost motion 'hammerblow' to assist in unseating tightly shut valves. A single worm and wheel drive run in an oil bath for maximum life with ambient temperature tolerance.

IQT motor

This is a high efficiency compact unit with a proven reliability record in valve actuation applications. Integrated speed control allows output speed adjustment over a 4:1 speed range.

7 Thrust base

Cast iron, water sealed bearings. Easily removable drive bushing for machining to suit valve stem for convenient valve adaptation.

*Minimum 6 mm / 1/4 inch padlock



Synchrophase prevents valve damage caused by incorrect wiring

Rotork's 'Synchrophase' automatic phase rotation correction control prevents valve damage caused by incorrect wiring by ensuring that the IQ three-phase motor is always presented with the correct phase rotation. Synchrophase senses the incoming phase rotation then energises the appropriate contactor to cause movement in the correct direction.

Single phasing protection*

IQ Pro control monitors all three phases of the power supply. Should one or more phases be lost the control system inhibits operation, preventing motor "single phasing" and burn out. The actuator display will indicate "phase lost", remote indication is also available from the configurable indication contacts.

Valve jammed protection

The actuator faces its severest operating test during unseating of the valve, when operating forces are at their highest or where an infrequently operated valve can get stuck. IQ Pro has the intelligence to systematically cope with these demands, ensuring reliable valve operation together with valve and actuator protection.

If valve "sticking" is considered possible, as with a wedge gate type, the torque switches can be by-passed during the first 5% of travel away from the valve seated position. This allows "extra" torque, averaging between 1.4 times and 2 times rated, to be applied in unseating the valve. In the majority of cases, applying additional force causes the sticky valve to move and allows operation to continue. After the 5% position has been reached, the torque switches return to the correct setting for the rest of travel. If this additional torque is still insufficient to cause movement IQ Pro recognises the valve is jammed and stops operation within seconds preventing further valve damage or motor burn out.

IQ thermostatic protection

In the event of overheating, two thermostats embedded in the motor windings directly sense the temperature and trip the actuator control circuit.

IQ thermostatic protection

Two thermostats are embedded within the motor power module providing comprehensive motor and motor power module protection.

Auto self test and diagnosis (ASTD)

Vital operational circuits automatically self test to ensure correct operation. In the unlikely event that a fault is diagnosed the information is automatically presented using the display text. At the same time, actuator operation can be inhibited to enable on-site investigation.

Instant reversal protection

When an actuator is ordered to reverse direction 'instantaneously' an automatic time-delay circuit avoids the shock loads which may cause unnecessary wear to valve stems and gearboxes. The delay also limits current surges through the contactor.

* IQ 3-phase only.

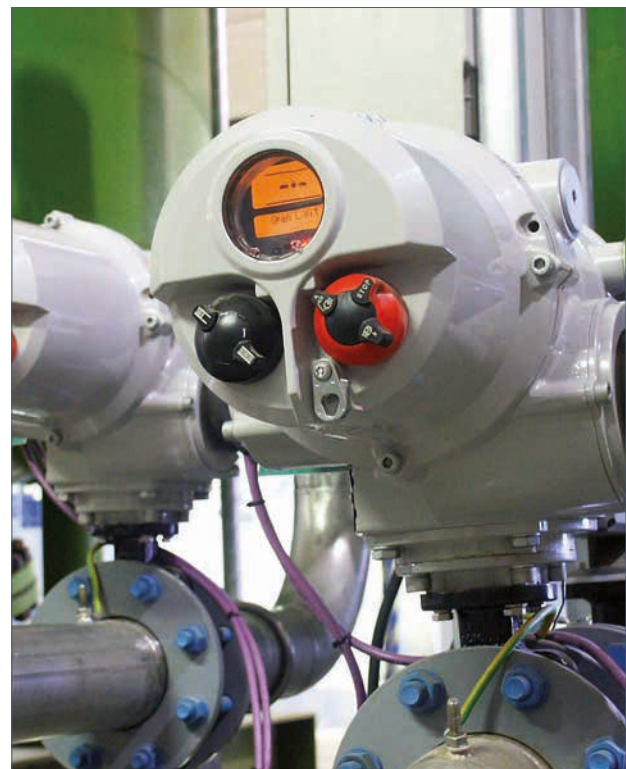



Protection - the key

Vast experience in the application of electric actuators has enabled Rotork to set the global standard in actuator ingress protection. Actuators have to perform unfailingly in environments ranging from desert to tundra, offshore to underground, where flooding, humidity, extremes of heat and cold, ultra violet and corrosive atmospheres are the norm. Rotork understands that the most important factor in the reliability of an actuator is protection from the environment - in simple terms, the enclosure.

Double-sealed for double protection

The IQ enclosure is rated IP68 - 7 metres for 72 hours, NEMA 4/4X/6. It is completely watertight and dusttight and does not "breathe". The Rotork 'double-seal' system ensures protection of internal components, separating them from the cable gland and terminal compartment by a watertight terminal block. Protection is maintained during site installation when terminal covers are removed and is independent of cable gland sealing.

Non-intrusive - sealed for life

IQ covers need not be removed for site commissioning. All settings and adjustments are made using the supplied infrared setting tool, including speed setting for the IQT. After assembly in the controlled environment of our manufacturing facilities, air exchanges are eliminated - all internal components are completely protected for life. Non-intrusive control selectors mean there are no moving shafts penetrating the control enclosure.

Reliability through simplicity

The IQ combines simplicity of design while extending specification and performance.

Torque measurement

An actuator's ability to reliably and accurately determine the force applied in operating a valve is fundamental to providing good valve and actuator protection. The IQ range uses tried and tested technology, proven in industry. Accurate, repeatable torque measurement is achieved independent of variations in frequency, voltage and temperature.

Position measurement

Reliable process control depends on accurate positioning of the valve throughout travel. The patented IQ non-contacting position measuring system is the most simple design devised for actuator control to date. With only one moving part, the resolver converts output centre column rotation into an electronic signal, which is then compared to position limits stored within a safe, non volatile memory.

IQT speed control

Using proven motor control technology, the output speed of the IQT can be adjusted without affecting the torque output.



Design features – intelligent communication

Lifetime support

Rotork understands its customer's need for back up support. The costs and penalties of plant downtime, delayed commissioning schedules and inappropriate maintenance are too high to allow for inefficient support.

With IQ - IrDA™ (Infrared Data Association) communication and the onboard data logger, the IQ now offers unrivalled support to provide complete product back up with analysis and configuration. With Rotork's unrivalled worldwide service, network expert advice is always close to hand.

Remote diagnosis - IrDA™

The IQ utilises IrDA™ communication for fast, safe, non-intrusive and standardised data exchange. Actuator set-up configuration can be analysed and, if required, changed. As every IQ includes an onboard data logger, operational data such as valve torque profiles, actuator events and statistics can be downloaded for detailed investigation. Data logger information can also be relayed to a user site base via an IrDA™ compatible PDA. After analysis, any changes to the actuator set-up configuration can be relayed back to the actuator.

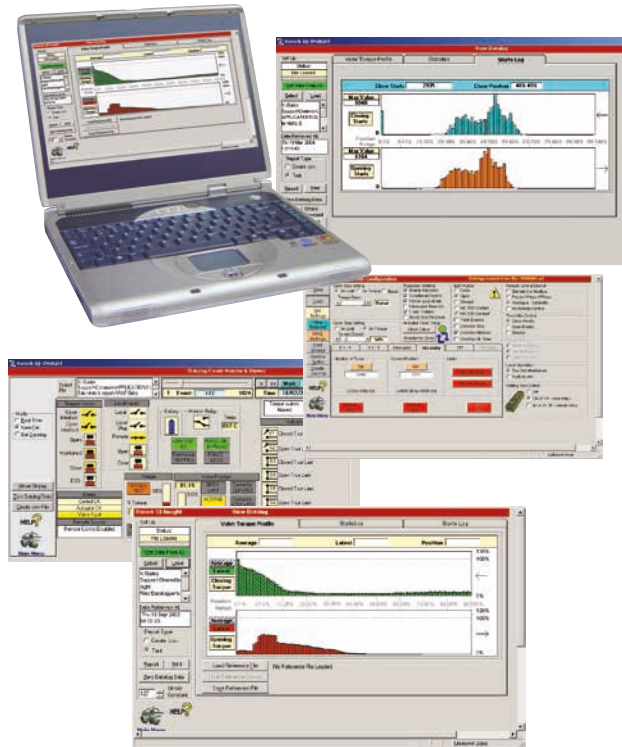

PC tools - IQ-Insight - Pocket-Insight

IQ-Insight PC software is a graphical user interface allowing all IQ set-up configuration and data logger information to be reviewed, analysed and reconfigured. This visually interactive application is browser based, running under Microsoft or other internet browser systems.

Intuitive controls make analysing the data from an IQ simple and fast. Laptop PCs with IrDA™ interface running IQ-Insight can be directly connected to an actuator located in the field to allow set-up, adjustment and analysis.

Alternatively, data can be uploaded from the actuator and later downloaded to a PC by using a PDA running IQ Pocket-Insight freeware.

Rotork help - online

Rotork has a comprehensive worldwide service network to provide you with local support wherever you are. Rotork trained technicians working from our network of offices and centres of excellence are available to offer immediate assistance.

To contact Rotork, visit www.rotork.com



Design features – customising

Although Rotork's standard IQ *Pro* actuator offers wide ranging control and indication flexibility, a variety of features can be customised to individual customer requirements. IQT *Pro* provides direct operation of small to medium sized quarter-turn valves up to 2,000 Nm. IQ *Pro* actuators can also be fitted with part-turn worm and wheel gearboxes to provide increased torque at reduced speeds for the operation of part-turn valves. A sizing program for both part-turn and multi-turn applications is available on the rotork website www.rotork.com

Floor mounting for easy remote coupling

Floor stands with upward or downward stubshafts are available for coupling to remote valves via customer shafts and universal joints.

Damper actuators

Single blade and multi-vane dampers can be motorised either by direct connection to the damper spindle or by lever arm.

Valve stem expansion

The stems of positive seating valves, such as solid or flexible wedge gates may be subject to significant expansion when used in high service temperature applications resulting in damaged or leaking valves. The effects of this expansion or contraction may be overcome by fitting the Rotork temperature compensator to the output of the IQ *Pro* actuator.

Rotork Site Services (RSS)

RSS is an illustration of Rotork innovation in practice. Throughout the company's history, aftermarket services such as retrofit and maintenance have developed to support customers and reinforce Rotork's market leading position. As a result, in some countries Rotork is now the number one service supplier for valve actuation. For detailed information on Rotork Site Services see page 46.

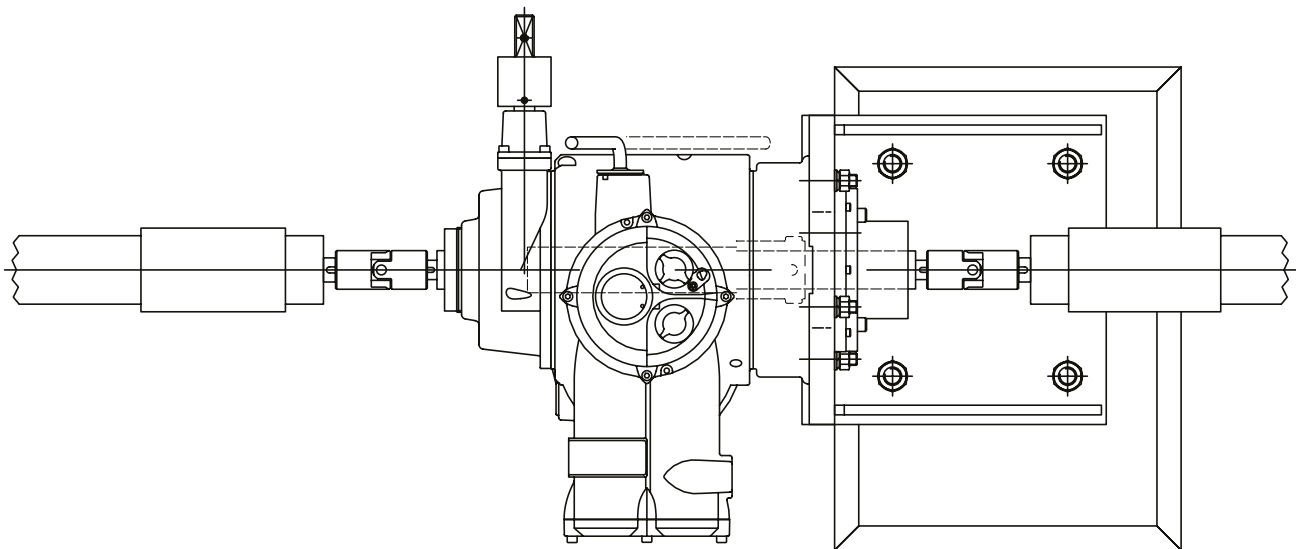

Rotork *Pakscan* and Rotork *Master Station*

Integration of the plant controls by use of network connectivity has been a hallmark of Rotork actuator products for many years. The use of proprietary and open systems makes the commissioning of the plant and the subsequent control and monitoring a simple and reliable task.

All Rotork actuators are compatible with a wide range of communication and process controls systems by including the appropriate option card during manufacture of the actuator. The actuator reports status feedback, via the field highway, to the overall plant control system (DCS or PLC) and valve control commands are actioned.

Our own *Pakscan*[™] system compliments the open systems from Foundation Fieldbus[®], Profibus[®], Modbus[®] and DeviceNet[®] see page 16 for more details. Innovative technology together with expert bus system knowledge ensures that Rotork can always provide the ideal solution for the control system.



Rotork *Pakscan* - the total control solution

Whether you need remote control of a few motorised valves, or full automation of a complex plant, *Pakscan* can help you to achieve significant savings in both time and costs.

Pakscan allows the remote control of actuators and valves over a simple single twisted pair data highway, removing the need for heavy multicore cables. It also includes automatic inbuilt redundancy of the field network to ensure control will be maintained even in the event of equipment or cable failure.

Available as a single or hot standby master station variant, *Pakscan* has the ability to control up to 240 actuators, and other field devices, using secure field communications. The field data highway cable may be up to 20 km in length so even quite distant valves can easily be incorporated into the network, without the need for repeaters.

Simple to install and simple to use, the highly successful *Pakscan* system has proved its value on many varied sites with over 70,000 *Pakscan* actuators installed worldwide.

Rotork *Master Station*

A simple, yet intelligent, control centre, capable of operating up to 240 actuators in a single loop, with a touch screen interface for ease of use. The Rotork *Master Station* and its field networks have been designed for use in all industries and applications where robust and reliable plant control and monitoring is required.

The *Master Station* provides the high integrity link from the Distributed Control System (DCS) to the devices in the field.

It comes complete with a large touch screen interface to allow operators and engineers to see exactly what is happening to the system and the field devices at any time.

A hot standby Rotork *Master Station* allows for continued availability of the system in the event of a component failure. Host ports allow connection to multiple host systems at the same time with redundant communication links where necessary. In the event of a fault occurring, the changeover to the standby is seamless without loss of data and control.

For further details see publication PUB059-048.

Rotork Master Station - network capabilities

Redundant Host Ethernet Modbus TCP connection as standard with optional redundant Host serial Modbus RTU connection available.

rotork[®] Master Station



■ Pakscan Classic field network Add In Module (AIM)

The Pakscan Classic redundant loop network has been the network of choice for actuator control for over 30 years. Using robust current loop technology, up to 20 km loop lengths, two independent loops and 240 field devices are possible.

■ Modbus field network Add In Module (AIM)

Modbus field network with standard highway or redundant loop topology options. Other manufacturers' devices are integrated into the network by use of a Rotork field device description file.

Multiple fieldbus connectivity

In addition to being fully compatible with Rotork *Pakscan*, IQ *Pro* actuators can be specified to interface seamlessly to many other fieldbus digital control systems. Open fieldbus protocols, such as Profibus and Modbus, are all available within the IQ actuator control option range.

This is achieved simply and cost effectively through fitting an appropriate Rotork manufactured circuit board module inside the actuator's electrical housing, normally at the time of production. Module commissioning and setup is carried out using a combination of the Actuator Setting Tool *Pro* BTST v1.1 and the network commissioning tools used for the chosen protocol.



Profibus

Profibus is a leading international network protocol for high speed data communications in industrial automation and control.

The Rotork Profibus DP interface card provides comprehensive control and feedback data about the valve and actuator using DP-V0 cyclic communications whilst extended actuator diagnostics and configuration is included in the DP-V1 acyclic data supported by this module.

EDD and DTM files allow the Rotork device to be incorporated into asset management systems giving access to performance critical parameters, whilst the independently certified GSD file guarantees device interoperability.

Rotork provide an optional switch disconnect module allowing for ease of installation and have multiple configuration options within the GSD file to enable a choice of data collection.

- RS485 Profibus DP V0 and V1 compliant
- Single and dual redundant options
- Fully meets IEC61158-3 standard
- Profibus PNO certified
- Supports speeds up to 1.5Mbit/s

Modbus®

Modbus

Modbus remains the most popular process communication protocol in use today with the widest acceptance and highest number of applied systems of any automation protocol.

Rotork's Modbus interface card allows actuators to be connected to a 2 wire RS485 network for direct communication to a PLC or DCS using Modbus RTU protocol. The resulting network is able to monitor and control the connected actuator.

As the Modbus protocol is so simple the system engineer has full control over the data flow on the highway and the information to be collected and controls implemented.

There are no complications with device description files or special programming tools required when setting up a Modbus system.

- RS485 2 wire RTU communication
- International open standard
- Dual redundant only
- Integral repeater modules included where necessary
- Up to 115 kB



IQ range actuators perform unfailingly in environments ranging from desert to tundra, offshore to underground, where flooding, humidity, extremes of heat and cold, ultraviolet and corrosive atmospheres are the norm.

IQ actuators have a record of reliability and safety that is second to none.



Actuator specification

The following pages contain details on performance and specification for the Rotork IQ range of actuators.

Please use the following contents table to help access the information you require.

Section	Title	Page
1	Performance summaries	20
2	Actuator drive couplings	24
	Standard specifications	26
3	Introduction	26
4	Valve type – actuator selection guideline	28
5	Design specification	29
5.1	Duty rating	29
5.2	Design life	29
5.3	Vibration, shock and noise	29
5.4	Valve / actuator interface	30
5.5	Operating temperature	30
6	Non-hazardous & hazardous certified enclosures	31
6.1	Non-hazardous area enclosures	31
7	Regulatory standards	32
8	Power, control & indication	33
8.1	Power supplies	33
8.2	Local control, indication & set-up	34
8.3	Remote control & indication	35
8.4	Fieldbus system control options	37
9	Protection & operating features	38
10	Components	40
10.1	Handwheel	40
10.2	Lubrication	41
10.3	Finish	41
10.4	Motor	42
10.5	Power module	43
10.6	Torque sensor	43
10.7	Position sensor	43
10.8	Control module	44
10.9	Conduit / cable entries	45
10.10	Terminals	45
10.11	Wiring	45
10.12	Battery	45

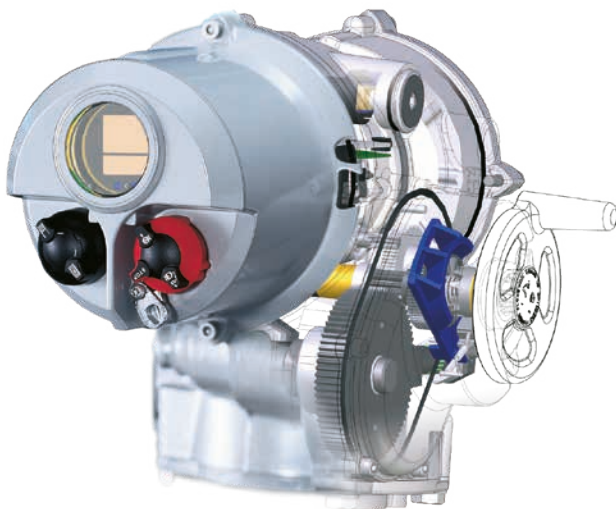



IQ 3-phase performance summary

1 Performance summaries IQ 3-phase – performance data

rpm at 50 Hz	Actuator output speeds							
	18	24	36	48	72	96	144	192
rpm at 60 Hz	21	29	43	57	86	115	173	230
Actuator size	Torque ³		Nm	lbf.ft				
IQ10	34	34	34	34	34	34		
	25	25	25	25	25	25		
IQ12	81	81	81	68	47	41		
	60	60	60	50	35	30		
IQ18	108	108						
	80	80						
IQ20	203	203	203	203	176	142	102*	
	150	150	150	150	130	105	75*	
IQ25	400	400	298	244	244	230	149*	
	295	295	220	180	180	170	110*	
IQ35	610	610	542	474	474	366	257*	
	450	450	400	350	350	270	190*	
IQ40	1020	1020	845	680	680	542	406*	
	750	750	625	500	500	400	300*	
IQ70	1490	1490	1290	1020	1020	745	645*	542*
	1100	1100	950	750	750	550	475*	400*
IQ90	2030	2030	1700	1355	1355	1020	865*	730*
	1500	1500	1250	1000	1000	750	640*	540*
IQ91							1355*	1355*
							1000*	1000*
IQ95		3000						
		2200						

* Due to the effects of inertia and drive nut wear, speeds not recommended for direct mounted gate valve applications.

** Torque rating is maximum torque setting in both directions. Stall torque will be 1.4 to 2.0 times this value depending on speed and voltage.

If maximum torque is required for more than 20% of valve travel, refer to Rotork.



IQ performance summary

Mechanical data

Actuator size IQ	10	12	18	20	25	35	40	70	90	91	95
Flange size	ISO 5210	F10	F14	F16	F16	F25	F25	F25	F30*	F25	F30
	MSS SP - 102	FA10	FA14	FA16	FA16	FA25	FA25	FA25	FA30*	FA25	FA30
Approximate weight**	kg	27	46	69	190	190	200	200	200	200	200
	lbs	60	101	152	418	418	440	440	440	440	440

Group A couplings (thrust)

Thrust rating	kN	44	100	150	220	220	334	N/A	445
	lbf	10,000	22,480	33,750	50,000	50,000	75,000	N/A	100,000

Stem acceptance diameter – Type 'A' (maximum)

Rising	mm	32	38	54	64	70	70	N/A	N/A
	in	1.25	1.5	2.125	2.5	2.75	2.75	N/A	N/A

Non-rising	mm	26	32	45	51	57	57	N/A	N/A
	in	1	1.25	1.75	2	2.25	2.25	N/A	N/A

Type 'Z' - 'Z3'

Z Rising	mm	N/A	51	67	N/A	N/A	N/A	N/A	N/A
	in	N/A	2	2.625	N/A	N/A	N/A	N/A	N/A

Z3 Rising	mm	2	51	67	73	83	83	N/A	83
	in	1.25	2	2.625	2.875	3.25	3.25	N/A	3.25

Non-rising	mm	N/A	38	51	57 ††	73 ††	73 ††	N/A	73 ††
	in	N/A	1.5	2	2.25 ††	2.875 ††	2.875 ††	N/A	2.875 ††

Group 'B' couplings (non-thrust) – Bore diameter

Type 'B1' (fixed bore)	mm	42	60	80	100	100	120	100	N/A
------------------------	----	----	----	----	-----	-----	-----	-----	-----

Type 'B3' (fixed bore)	mm	20 †	30 †	40 †	50	50	50	50	N/A
------------------------	----	------	------	------	----	----	----	----	-----

Type 'B4' (maximum)	mm	20 †	32 †	44 †	50	60	60	60	N/A
	in	0.75	1.25	1.75	2	2.25	2.25	2.25	N/A

Handwheel ratio

Actuator size	10, 12, 18	20, 25	35	40	70	90	91	95
Standard	Direct	Direct	Direct	Direct	15:1	15:1	15:1	15:1
Option	12:1	13.5:1	22.5:1	15:1				

* IQ90 with B3 and B4 couplings have flange size F25. ** Weight will be dependent on optional equipment fitted.

† For actuator sizes IQ10 to IQ35 a type 'A' coupling must be used when required to drive shafts or stems having any axial movement.

†† Utilises Z3 form drive coupling.



IQT part-turn performance summary

Performance and mechanical data

Actuator	IQT125	IQT250	IQT500	IQT1000	IQT2000
----------	--------	--------	--------	---------	---------

Torque

Max Nm	125	250	500	1000	2000
Min Nm	50	100	200	400	800
Max lbf.ft	92	185	369	738	1476
Min lbf.ft	37	74	148	295	590

Operating time

90° Min	5	8	15	30	60
90° Max	20	30	60	120	120

Flange

ISO 5211	F05*	F07*	F10	F07*	F10	F10	F12	F14*	F14
MSS SP-101	FA05*	FA07*	FA10	FA07*	FA10	FA10	FA12	FA14*	FA14

Weight

kg	22	22	22	37	37
lbs	49	49	49	82	82

Couplings**

Spindle acceptance

Bore & key max mm	22	28	42	28	42	42	60	60
Bore & key max ins	0.87	1.1	1.65	1.1	1.65	1.65	2.36	2.36
Square AF max mm	14	19	32	19	32	32	41	41
Square AF max ins	0.56	0.75	1.25	0.75	1.25	1.25	1.62	1.62

Handwheel

Turns for 90°	80	80	80	80	80
---------------	----	----	----	----	----

Angular adjustment

(nominal) degrees	80 - 100	80 - 100	80 - 100	80 - 100	80 - 100
-------------------	----------	----------	----------	----------	----------

IQT 24 VDC (17-37 Volts) performance

Torque outputs for 24 VDC are the same as above, however speed varies with load.

* Optional flanges F05, FA05, F07 and FA07 use a base adapter plate. Required base type must be specified.

** Couplings are supplied blank for machining by valve maker.



IQM performance summary

Performance data

Actuator size	Base sizes to ISO 5210	Thrust rating	Max. rising stem dia.	Torque**	Actuator output speeds									
					Nm		lbf.ft		rpm at 50 Hz					
IQM10	F10	44 kN	32 mm	Modulating torque	17	12.5	17	12.5	15.6	11.5	13.6	10	-	-
		10,000 lbf	1.25 ins	Max. seat. torque	34	25	34	25	30	23	27	20	-	-
IQM12	F10	44 kN	32 mm	Modulating torque	34	25	34	25	30	22	27	20	-	-
		10,000 lbf	1.25 ins	Max. seat. torque	61	45	54	40	54	40	48	35	-	-
IQM20	F14	100 kN	51 mm	Modulating torque	81	60	81	60	68	50	54	40	47	35
		22,480 lbf	2 ins	Max. seat. torque	122	90	109	80	81	60	68	50	54	40
IQM25	F14	100 kN	51 mm	Modulating torque	152	112.5	152	112.5	129	95	102	75	102	75
		22,480 lbf	2 ins	Max. seat. torque	204	150	204	150	163	120	136	100	136	100
IQM35	F16	150 kN	54 mm	Modulating torque	271	200	271	200	253	187	203	150	203	150
		33,750 lbf	2 1/8 ins	Max. seat. torque	544	400	544	400	408	300	313	230	218	160



IQTM performance summary

	Torque						Operating time 90° max
	Max Nm	Modulating Nm	Min Nm	Max lbf.ft	Modulating lbf.ft	Min lbf.ft	
IQTM125	125	62.5	50	92	46	37	20
IQTM250	250	125	100	185	92.5	74	30
IQTM500	500	250	200	369	184.5	148	60
IQTM1000	1000	500	400	738	369	295	120
IQTM2000	2000	1000	800	1476	738	590	120

Actuator drive couplings

2 Actuator drive couplings

The IQ *Pro* range features two actuator base designs - a removable base for the IQ10, 12, 18, 20, 25 and 35 sizes and an integral base for IQ40, 70, 90, 91 and 95. Both arrangements are available with flanges and couplings that comply with either ISO 5210 or MSS SP-102.

Thrust bearings

Both type 'A' and 'Z' couplings feature an associated thrust bearing. In the case of the removable thrust base this is fully sealed and lubricated for life; in the integral base design this is lubricated by the actuator gearcase oil bath. Both integral and removable thrust bases are designed to retain all developed thrust reaction forces without any load appearing on the actuator gearcase.

Drive couplings

For convenient valve adaption the easily removable drive bush is supplied blank for machining to suit valve stem. The IQT *Pro* base design and drive couplings comply with either ISO 5211 or MSS SP-101.

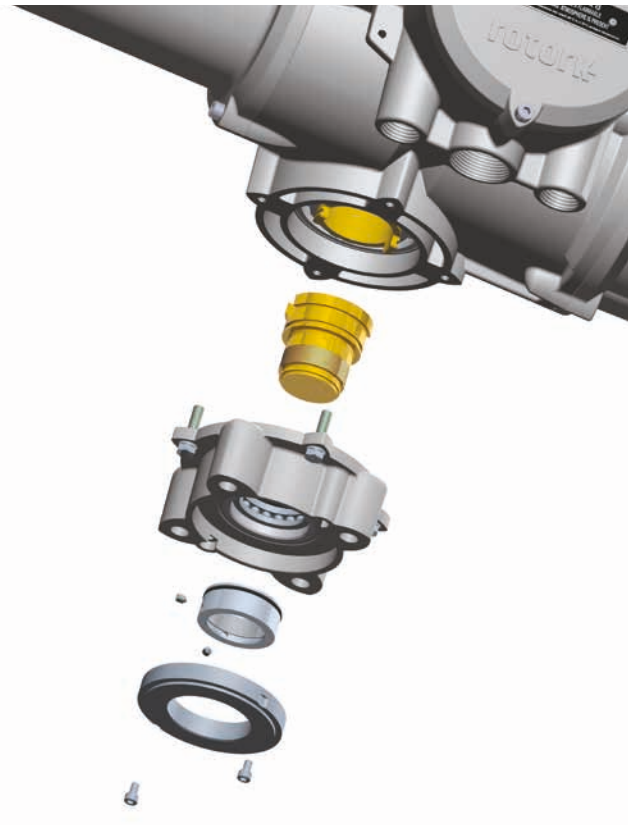

IQ actuator drive couplings IQ10 to IQ35

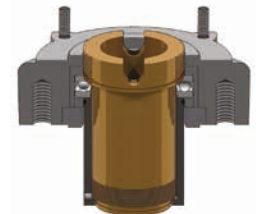
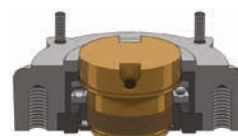
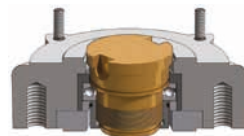

Type A
for sizes IQ10 to 35

Type Z
for sizes IQ20 to 35
increased stem
acceptance

Type Z3
for sizes IQ10 to 35
increased stem
acceptance and reach

Actuators:

IQ10 IQ12 IQ18
IQ20 IQ25 IQ35

Thrust

Non-thrust

for sizes IQ10 to 35
large fixed bore with
ISO standard bore
and keyway

for sizes IQ10 to 35
fixed bore with ISO
standard bore
and keyway

for sizes IQ10 to 35
blank drive bush
for machining by
customer

Type B1

Type B3

Type B4

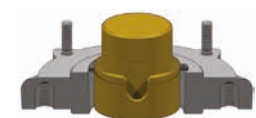
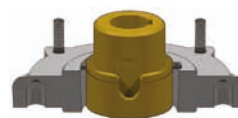
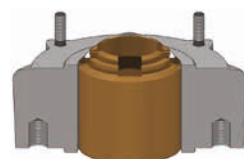

IQ actuator drive couplings
IQ40 to IQ95

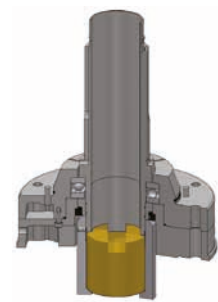
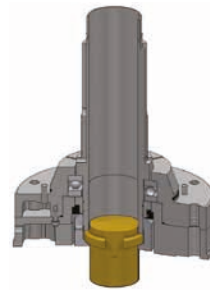
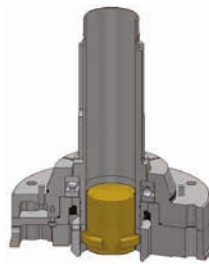

position 1

Type A

position 2

for sizes IQ40 to 90

Type Z3

for sizes IQ40, 70, 90 and 95
increased stem acceptance and reach

Actuators:

IQ40 IQ70 IQ90
IQ91 IQ95

Thrust

Non-thrust

for sizes IQ40, 70 and 90 large fixed bore with ISO standard bore and keyway

Type B1

for sizes IQ40, 70, 90 and 91 fixed bore with ISO standard bore and keyway

Type B3

for sizes IQ40, 70, 90 and 91 blank drive bush for machining by customer

Type B4

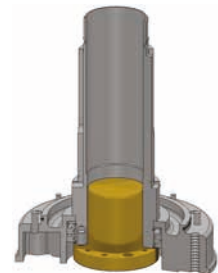
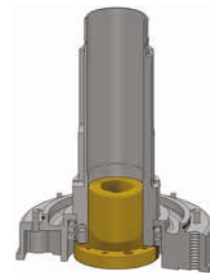
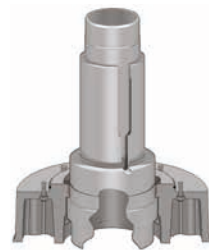

IQT actuator drive couplings



F05/FA05

for size
IQT125



F07/FA07

for sizes
IQ125/250

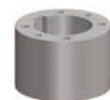

F10/FA10

for sizes
IQT125/250/500

Actuators:

IQT125 IQT250
IQT500

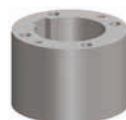

F12/FA12

for size
IQT1000



F14/FA14

for size
IQT2000

Actuators:

IQT1000 IQT2000

Standard specifications

3 Introduction

IQ and IQT *Pro* range actuators are self contained, purpose designed and built for the local and remote electrical operation of valves. Comprising an electric motor, reduction gearing, reversing starter with local controls and indication, turns and torque limitation with electronic logic controls and monitoring facilities housed in a double-sealed watertight enclosure.

All torque, turns settings and configuration of the indication contacts are made using the non-intrusive, handheld, infrared setting tool which is included with each order.

The specification detail in this section covers standard features and available optional features for the IQ and IQT *Pro* range. Enclosure requirement and build options selected must be specified with enquiry.

The selection guideline in section 4 allows specifiers to identify suitable actuator types for particular valve and process applications, checking actuator type against other specification requirements.

The example enquiry datasheet opposite provides an outline of the basic information required for quotation. Where there is a project, framework or job specification applicable, Rotork will be pleased to analyse it in detail, in which case only valve details are required. The applicable actuator specification detail paragraph number is listed under the reference column for information.

It is not necessary to specify the actuator type, size or speed – Rotork will provide the most cost effective solution based on the information provided.



Standard specifications

Page	Requirement	Options	Detail
28	Valve type	Part-turn	Ball/butterfly/plug – or other (specify)
		Multi-turn	gate/globe/penstock/sluiice or other (specify)
29	Duty cycle	Isolating	Starts/hour
		Regulating	Starts/hour
		Modulating	Starts/hour
20-23	Operating time or turns	Sec	Turns
20-23	Seating torque	Nm	lbf.ft
20-23	Running torque (if known)	Nm	lbf.ft
20-23	Thrust (multi-turn only)	kN	lbf
33	Power supply	3-phase	___Volts ___Hz
		Self contained	
		UPS or battery	
31	Enclosure	Non-hazardous	IP/NEMA rating
34	Local indication	Position display plus text display	Language required
35	Remote control	Contacts	Actuator powered/control system powered
		Analogue	4-20 mA other (specify)
		Digital bus-network	Type
35	Remote indication	Volt free indication contacts	
		4-20 mA position indication	
		Digital bus-network	

Standard specifications

4 Valve type – actuator selection guideline

Valve types are defined by the action required by the actuator for operation – multi-turn, part-turn or linear. The table below provides a guide to the actuators available and is determined by valve type, operating torque and duty requirement.

Actual selection may vary to those indicated below due to factors such as available power supply, mechanical interface, thrust requirements etc. Rotork will always offer the correct technical solution at the lowest cost for any application.

Valve type	Duty*	Torque min (Nm/lbf.ft)	Torque max (Nm/lbf.ft)	Actuator type	Comments
Multi-turn gate valves	On-Off & Inching	13/10	3,000/2,200	IQ	General gate valves, penstock/sluiice, Parallel slide, globe, choke
Multi-turn gate valves	On-Off & Inching	100/135	43,000/32,000	IQ + IS or IB gearbox	General gate valves, penstock/sluiice, Parallel slide globe, choke
Multi-turn low turns – non-thrust	On-Off & Inching	1,000Nm		IQ + MTW gearbox	Non-thrust applications such as cable operated river gates
Multi-turn control valve	Modulating	13/10	544/400	IQM	Control valves such as globe/cage/choke
Multi-turn control valve	Modulating	400	21,000/15,500	IQM + IB/IS gearbox	Control valves such as globe/cage/choke
Part-turn	On-Off & Inching	50/37	2,000/1,500	IQT	General 1/4 turn ball/butterfly/damper
Part-turn	On-Off & Inching	1,000/740	500,000/370,000	IQ + IW gearbox	General 1/4 turn ball/butterfly/damper
Part-turn	Modulating	40	2,000	IQTM	1/4 turn control valves ball, butterfly, damper
Part-turn	Modulating	400	2100	IQM + MOW gearbox	1/4 turn control valves ball, butterfly, damper

Standard specifications

5 Design specification

5.1 Duty rating

Duty classification*	Actuator type	Rating
On-Off & Inching	IQ	Nominal 60 starts per hour at a rate not exceeding 600 starts per hour. 15 minutes rated based on a nominal torque of 33% of rated
On-Off & Inching	IQT	Nominal 60 starts at a rate not exceeding 600 starts per hour. 15 minutes rated based on a nominal torque of 75% of rated
Modulating	IQM	Nominal 1,200 starts per hour, 50% duty cycle based on a modulating torque of 50% of rated torque
Modulating	IQTM	Nominal 1,200 starts per hour, 50% duty cycled based on a modulating torque of 50% of rated torque

5.2 Design life

Duty classification*	Actuator type	Size	Minimum design life rating
On-Off & Inching	IQ	10-35	Torque and thrust test: 10,000 cycles (500,000 output turns) seating at rated torque, 33% rated torque through stroke
		40-95	Torque and thrust test: 5,000 cycles (250,000 output turns) seating at rated torque, 33% rated torque through stroke
Modulating	IQM	12-35	1,800,000 starts at load of 50% rated torque (1 start constitutes at least 1° movement)
On-Off & Inching	IQT	All sizes	Torque test: 25,000 cycles seating at rated torque, 70% rated torque through stroke
Modulating	IQTM	All sizes	1,800,000 starts at load of 70% rated torque (1 start constitutes at least 1° movement)

Design life is a function of actuator torque and speed. Values quoted are the minimum requirements; for most sizes/speeds life will be extended above the values quoted. Actuators are stalled against a solid object 25 times to prove durability. Contact Rotork for more information

5.3 Vibration, shock and noise

Standard IQ and IQT *Pro* Range actuators are suitable for applications where vibration and shock severity does not exceed the following:

Type	Level
Plant induced vibration	1g rms total for all vibration within the frequency range of 10 to 1000 Hz
Shock	5g peak acceleration
Seismic	2g acceleration over a frequency range of 1 to 50 Hz if it is to operate during and after the event
Emitted noise	Independent tests have shown that at 1m generated noise does not exceed 61 db(A)

Levels quoted are those present at the actuator mounting interface. It should be noted that the effects of vibration are cumulative and therefore an actuator subjected to significant levels may have a reduced lifespan. Where excessive plant induced vibration is anticipated, mounting the actuator remote from the valve and driving via extension shafting (incorporating vibration absorbing couplings) may provide a satisfactory solution.

Standard specifications

5.4 Valve / actuator interface

The IQ and IQT *Pro* range of actuators are available with mounting base and output drive couplings conforming to the following international standards:

Valve to actuator interface:

Valve type	Actuator range	Area	Standard	Code
Multi-turn	IQ	International	ISO 5210	"F" metric
Multi-turn	IQ	USA	MSS SP-102	"FA" imperial
Part-turn	IQT	International	ISO 5211	"F" metric
Part-turn	IQT	USA	MSS SP-101	"FA" imperial

Applications for which the various types of couplings have been designed are outlined on pages 24-25.

5.5 Operating temperature

Actuators are suitable for operation within the ambient temperature ranges shown below. Refer to Section 6 for hazardous area certification operating temperature restrictions. For temperatures outside this range please contact Rotork. Prior to installation actuators should be stored in a dry location with a temperature range not exceeding -60 to +80 °C (-76 to +176 °F).

Actuator type	Standard temperature	Low temperature option
IQ, IQM	-30 to +70 °C (-22 to +158 °F)	-40 to +70 °C (-40 to +158 °F)
IQT, IQM	-30 to +70 °C (-22 to +158 °F)	-40 to +70 °C (-40 to +158 °F)

Standard specifications

6 Non-hazardous & hazardous certified enclosures

All IQ actuator hazardous and non-hazardous area enclosures are watertight to IP68/NEMA 4 & 6. Through the use of non-intrusive commissioning and adjustment using the supplied infrared setting tool, covers never need removing and therefore the hermetic, factory-sealed enclosure protects internal components for life. The terminal compartment is sealed from other areas by the Rotork double seal, maintaining watertight integrity even during site connection.

In addition, the setting tool is certified intrinsically safe, permitting power-on commissioning in hazardous areas.

Actuators are available with the following enclosure types for which the ambient working temperature ranges are stated. Where option temperatures are indicated, changes to some actuator components are required and therefore the temperature requirement must be specified. Hazardous area approvals for other country standards are available; please contact Rotork.

The IQ and IQT *Pro* range are available built in accordance with the following standards:

6.1 Non-hazardous area enclosures

WT: Standard watertight

Standard	Rating	Standard temperature	Option 1
IEC 60529 (1989-11)	IP68 – 7 metres / 72 hrs	-30 to +70 °C	-40 to +70 °C
BS EN 60529 (1992)	IP68 – 7 metres / 72 hrs	-30 to +70 °C	-40 to +70 °C

Standard specifications

7 Regulatory standards

Compliance with the following European Economic Community (EEC) directives permits the IQ and IQT *Pro* range actuators to be CE marked under the provision of the Machinery Directive.

Directive	Applicable to	Reference
Electromagnetic compatibility (EMC)	Immunity to/emissions of electromagnetic energy	89/336/EEC as amended by 92/31/EEC
Low voltage (LV)	Electrical Safety	73/23/EEC amended by 93/68/EEC by the application of EN 60204-1 1993
Machinery*	Product safety	Actuators follow the provision of the Machinery Directive (89/392/EEC) as amended by 91/368/EEC and 93/44/EEC. The IQ must not be put into service until the equipment into which it is being incorporated has been declared to be in conformity with the provisions of the European Community Machinery Directive (89/392/EEC) 91/368/EEC and 93/44/EEC*
Waste Electrical Equipment (WEE)	Exempt under the scope of the directive	

*Actuators are not classified as machines within the scope of the machinery directive.
Contact Rotork for a copy of our Declaration of Conformity and Incorporation



Standard specifications

8 Power, control & indication

8.1 Power supplies

IQ and IQT *Pro* actuators are suitable for operation with the following 3-phase - three wire supplies:

Supply voltage ranges – Actuator availability

Standard voltages	Phase	IQ10 to IQ70 & IQ95	IQ90 & IQ91	IQM	IQT IQTM
24	DC	X	X	X	✓
100, 110, 115, 120	1	X	X	X	✓
208, 220, 230, 240	1	X	X	X	✓
200, 208, 220, 230, 240	3	✓	X**	✓	✓*
380, 400, 415, 440, 460, 480	3	✓	✓**	✓	✓*
500, 550, 575, 590	3	✓	✓	X	✓*
600, 660, 690	3	✓	✓	X	✓*

Voltage tolerance	+/-10%	Applies for rated torque performance; duty cycle and speed is not guaranteed
Frequency tolerance	+/-5%	Applies for rated torque performance; duty cycle and speed is not guaranteed
Max. starting volt drop	-15%	Actuators capable of starting and running up to speed
Non standard tolerances	Larger volt drops / frequency variations than those quoted can be catered for but may affect actuator selection / sizing. Contact Rotork	
Uninterruptible Power Supply (UPS) systems	For AC systems, UPS systems should conform to recognised supply standards such as EN60160 in respect of waveform, spikes, harmonics etc. The tolerances above should not be exceeded.	

* IQT/IQTM ranges - 3-phase supplies

The IQT utilises 2 phases only. A parking terminal for phase 3 is available for systems where all 3 phases are distributed. For multiple actuators, even diversity over all three phases should be considered.

** Limited availability

IQ91 not available at 380 V 60 Hz. IQ90 has limited availability at voltages up to 240 V.

Reference documents

For operating electrical consumption data refer to PUB002-018 (IQ ranges) and PUB002-032 (IQT ranges) available to download at rotork.com

Standard specifications

8.2 Local control, indication & set-up

Non-intrusive selectors are provided on the actuator electrical control cover which also includes a window showing actuator position, status and alarm display.

The control cover may be rotated through 360° (90° increments) to suit actuator orientation/operator access. Set-up is over an infrared interface using the supplied setting tool.

Standard local controls

Operation	Type	Function	Comments
Control mode	Red, rotary selector	Selects "Local", "Stop" or "Remote" control	Can be padlocked in each position (stop remains available) for site operational protection
Local control	Black, rotary selector	Initiates local "Open" and "Close" operation	Spring-return to centre neutral position. Local control may be user configured for inching action
Infrared	Actuator Setting Tool Pro BTST v1.1	Initiates local "Open" and "Close" operation	May be user configured for infrared operation over a nominal distance of 0.5 m (1.5')

Standard local indication

Operation	Type	Function	Comments
Position indication	LCD - Large character (16 mm/0.6")	Open / close icons + 0-99% in 1% increments	Back-lit (power on) – operating temperature range -50 to +70 °C (-58 to +158 °F) Battery supported power off
Position indication	Coloured indication lights	Green (close), Red (open), Yellow (mid-travel)	Power on – lamp indication, colours can be reversed
Status and alarm	LCD – text display 2 x 16 characters	Real time valve & actuator status and alarm text messages	Power on – battery supported (when awake) Multilingual-English plus 1 option: E, D, Fr, Ru. Single Chinese available (Mandarin).
Status and alarm	General alarm icon Battery alarm icon	Warning triangle Battery icon	Power on & off – indication of active alarm Power on & off – indication of low battery
Status and alarm	Help screens	8 realtime help screens (icon + text)	Complimentary to status/alarm text display

Actuator set-up, configuration & data logging

Setting tool LCD displays	Simple non-intrusive, interactive set-up procedure using supplied infrared setting tool with read-back from LCDs. Settings include limits & torque switching, indication contacts and control options. Settings may be password protected. Setting tools are provided on a 1 per order basis
PC/PDA	Using freeware IQ-Insight, actuators may be configured/analysed over IrDA™ interface
Data logging	Standard onboard data logger provides valve torque and starts profiles, operational statistics, events log. Actuator configuration & manufacturing data also available. Files can be downloaded direct to PC or to the supplied setting tool (IS certified) for transport to office PC. Freeware IQ Insight for PC is available to download at www.rotork.com

Reference documents

Refer to PUB002-217 (IQ Pro) / PUB002-218 (IQT Pro) for details of status and alarm text messages, alarm icons, help screens and actuator set up procedure. Refer to PUB095-002 for Actuator Setting Tool Pro BTST v1.1 / IQ Insight details

Standard specifications

8.3 Remote control & indication

IQ and IQT *Pro* range actuators enable remote control and indication of valves for centralised control. Actuator control and indication forms are available to meet the requirements of the various site control systems, from simple manual pushbutton control through to sophisticated distributed control systems (“DCS”) using relay outputs or digital “bus” network systems.

Standard remote controls

Operation	Type	Range	Comments
Open/Close/Stop Common	Positive switched 3 x Opto-isolated inputs designed for fleeting or maintained contacts	20-60 VAC/VDC, 120 VAC, 5 mA per input (12 mA at 120 VAC)	Actuator derived - 24 VDC (120 VAC available as an option) or externally supplied derived from the control system. Various forms available
ESD Open interlock Close interlock Common	Positive switched 3 x Opto-isolated inputs designed for maintained contacts.	20-60 VAC/VDC, 120 VAC, 5 mA per input. (12 mA at 120 VAC)	ESD can be user configured open, stayput or close, from a NO or NC contact. ESD has priority over all other applied local or remote control signals. Interlocks provide hardwired “permissive” protection (ie. main and bypass control) and are active for local and remote or may be configured for remote signals only

Options

Analogue control – Option Folomatic	0 to 5/10/20 mA or volt ranges	Proportional control over the whole or part of valve stroke. Configurable for open, close or stayput on loss of analogue signal
Hydraulic shock “water hammer”/surge protection – Option Interrupter timer	Internal control system	Pulsed operation with independently adjustable on and off time periods in the range 1-99 seconds can be selected to operate over any portion of the closing or opening valve stroke, effectively reducing valve speed.

Standard specifications

8.3 Remote control & indication cont.

Standard remote indication

Operation	Type	Range	Comments
Position, status and alarm indication	4 x Configurable volt-free latching contacts - S1 to S4. Single pole -single throw (SPST), configurable NO or NC.	5 mA to 5 A, 120 VAC, 30 VDC	Independently configurable using the supplied setting tool to signal one of the following: Valve Position: fully open, fully closed or intermediate positions (0-99% open) Status: Valve opening, closing, moving, Local stop selected, local selected, remote selected, open or close interlock active, ESD active Valve Alarms: Torque tripped in mid travel, going open, going closed, valve jammed, handwheel operation Actuator alarms: Lost phase (3-phase IQ only), customer 24 VDC (120 VAC) supply lost, battery low, internal failure detected, thermostat tripped
Actuator availability	Monitor Relay - Non-configurable relay - change over contact	5 mA to 5 A, 120 VAC, 30 VDC	The relay will de-energise when the actuator is unavailable for remote control due to any one or more of the following conditions: Power supply or control supply lost; local control selected; local stop selected; motor thermostat tripped; detected internal failure

Options

Operation	Type	Range	Comments
Position, status and alarm indication	4 x Configurable volt free latching contacts – S5 to S8. Single pole – change over (SPCO)	5 mA to 5 A, 120 VAC, 30 VDC	Independently configurable using the supplied setting tool as per contacts S1 to S4 above
Analogue position feedback	Current position transmitter - CPT	4-20 mA output proportional to position	Auto range to set limits. Normally internally powered, available suitable for externally "loop" powered (will default to 4 mA when actuator is powered down).

Reference documents

Refer to PUB002-002 IQ Pro range control and monitoring

Standard specifications

8.4 Fieldbus system control options

IQ and IQT *Pro* range actuators are available with the following network interface cards to enable remote control and indication using digital “bus” network systems communication to the control systems (“DCS”).

Standard remote controls

Network type	Comments
Pakscan™	An internally mounted Pakscan field unit for remote control and status indication over a fault tolerant two-wire serial link. Loop distances of up to 20 km without repeaters and host communications using Modbus protocol. System variables programmable over the infrared data link. For more information please refer to publication PUB059-048
Modbus®	Modbus modules suitable for dual communication highways may be included in the IQ and IQT actuator, to provide Fieldbus communication of all the actuator control functions and feedback data. Data is carried on an RS485 data highway and the communications protocol used is Modbus RTU. System variables such as unit address and data baud rate are programmed over the infrared data link. For more information please refer to publication PUB091-001
Profibus®	A Profibus DP interface module is available to allow the actuator to be integrated into a Profibus network. Full compatibility with EN 50170 is provided and the Profibus network allows full actuator control and feedback of data to the host. For more information please refer to publication PUB088-001

Standard specifications

9 Protection & operating features

The IQ and IQT *Pro* control system incorporates the following standard operating features and comprehensive valve, actuator and control protection to ensure reliable valve operation and protection under all circumstances.

Fault / feature	Cause / operation	Function
Obstructed valve	Valve meets an obstruction or process conditions that prevent movement. Obstruction must be sensed and operation prevented to prevent damage to valve and actuator	Independent Settable Open and Close Torque Switches Torque switch will "torque trip" the actuator motor when the preset output torque level is reached. Torque switches can be set in the range 40% to 100% of rated torque. Torque trips are indicated on the actuator display and can be remotely signalled
Jammed valve	Seated valve is stuck in its seat - often after long periods of inactivity	Jammed Valve Protection The motor is de-energized if no output movement occurs after a (nominal) 3 seconds from receipt of a signal to open or close. This prevents the actuator motor stalling for long periods and possible burn out. Torque trips are indicated on the actuator display and can be remotely signalled
Torque switch bypass	Provides increased torque above actuator rated for unseating sticky valves	Torque Switch By-pass User selectable – secondary setting "At". Torque switches are automatically bypassed during the first 5% of travel from both open and close limit positions. This permits torque above actuator rated torque and up to actuator stall torque (1.4 to 2.4 times rated torque) to be developed during unseating, ensuring "sticky" valves do not cause unwanted torque trips. Refer also to Jammed Valve Protection
Torque switch hammer	Actuator repeatedly tries to move an obstructed valve in response to a standing control signal. This can cause damage to both valve and actuator	Anti-Hammer Protection Once a torque trip occurs the control prevents repeated operation in the same direction as a response to a standing remote or local control signal. Actuator must be operated in the opposite direction and therefore moved away from the obstruction, which then has chance to clear, before it can be signalled to run in the requested direction. Torque trips are indicated on the actuator display and can be remotely signalled
Incorrect phase rotation (3-phase actuators only)	Due to 3-phase supply wiring incorrectly connected to actuator. Actuator moves in the opposite direction to that signalled. At end of travel the wrong limit/torque switch is activated preventing the motor being de-energised and causing it to stall with consequent valve damage and/or motor burn out.	Syncrophase™ Protection ensures actuator always runs in the correct direction corresponding to the applied control signal (open or close). The patented circuit senses connected phase rotation and ensures the actuator always runs in the correct direction by energising the appropriate motor control contactors/switches
Lost phase / motor overheating (3-phase actuators only)	"single phasing" one of the 3 phases applied to the actuator is lost due to fault causing the motor to single phase i.e. attempts to run with only 2 of the 3 phases applied. Motor may fail to start (stall) or run unbalanced causing overheating and possible burnout	Syncrophase™ The patented circuit monitors all three supply phases. If a phase is lost the Syncrophase circuit prevents the motor from being energised. If during operation one phase is lost this cannot be detected due to back-feed through the motor windings, however once operation stops, re-energising of the motor will be prevented. Lost phase is indicated on the actuator display and can be remotely signalled
Motor overheating	Actuator duty cycle is exceeded causing the motor to overheat. This often occurs during factory acceptance testing /commissioning or during process start up	Motor Thermostat Protection Two thermostats are embedded in the motor end windings (hottest part of the motor) which directly sense motor temperature. Thermostats will open circuit when set temperature is reached causing the motor to be de-energised. Thermostats will auto-reset once the motor has cooled sufficiently allowing operation to continue. Motor Thermostat trips are indicated on the actuator display and can be remotely signalled

Standard specifications

Fault / feature	Cause / operation	Function
Instantaneous reversal	Control system instantaneously reverses the control signal which causes the actuator to reverse direction with associated inertial stress to valve drive and internal motor switching surges	Instantaneous Reversal Protection A delay of 300 ms is automatically applied between reversals allowing the actuator to come to rest before responding to reverse control signal
Actuator fault	Control system instantaneously	Automatic Self Test and Diagnosis (ASTD) ASTD detects any internal control system failures preventing operation. Detected internal control system faults are indicated on the actuator display allowing rapid diagnosis and can be remotely signalled. In addition help screens can be accessed allowing problem to be pin-pointed
Remote control circuit failure (actuator derived remote control supply only)	Loss of remote control	The 24 VDC internal power supply made available for remote control switching is protected by an auto-reset fuse device. Should the power drawn from the supply exceed its rating (due to a remote control wiring fault, etc.), the fuse will disconnect the supply. Once the fault is cleared the supply will automatically be reinstated. Loss of internal supply is indicated on the actuator display and can be remotely signalled
Spurious operation	Operation commanded due to unintended or spurious remote control signals leading to process problems or hazards	Conditional Control User selectable – secondary settings A8 and A9. The interlock input can be configured for “conditional control”, being active only for remote control. In this mode, for the actuator to respond to a remote control signal, two signals must be applied simultaneously, one to the control input and one to the interlock input. If an unintended or spurious signal is applied only to the control input it will be ignored. Intended signals can therefore be verified by applying a second “permissive” signal, effectively preventing spurious operation. In addition the TÜV approved SFCM option is available for SIL 2 applications requiring safety function “stayput”. Refer to PUB002-009.
Emergency Shut Down (ESD)	Priority action where the valve is required to stayput or move to a safe end of travel position determined by the process (open or closed limit)	Dedicated ESD Control Input User configurable secondary settings A1 to A5 ESD action has priority over any existing or applied local or remote control signal. ESD can be configured to open, close or stayput depending on the process requirements. It must be derived from a stayput type, normally open or normally close ESD contact (configurable) and may be configured to override local stop, interlocks or interrupter timer. For IQ 3-phase units only, the TÜV approved SFCM option is available for SIL 2 applications requiring safety function “ESD”. Refer to PUB002-009

Standard specifications

10 Components

Details of major actuator mechanical and electrical/electronic components are provided below.

10.1 Handwheel

A handwheel is provided to allow manual operation of the valve during electrical power interruption. Handwheel size and mechanical advantage are generally designed in accordance with standards EN 12570 and AWWA C540

(American Water Works Association) to give the most efficient compromise of force and turns for emergency operation.

Handwheel turns:

Actuator range	Actuator size	Standard ratio / turns	Option 1	Option 2
<i>IQ Pro</i>	IQ10, IQ12, IQ18	1:1 (Direct)	12:1	X
<i>IQ Pro</i>	IQ20, IQ25	1:1 (Direct)	13.5:1	X
<i>IQ Pro</i>	IQ35	1:1 (Direct)	22.5:1	X
<i>IQ Pro</i>	IQ40	1:1 (Direct)	15:1	X
<i>IQ Pro</i>	IQ70, IQ91	15:1	X	X
<i>IQ Pro</i>	IQ90, IQ95	15:1	X	X
<i>IQT Pro</i>	IQT125, IQT250, IQT500	80 turns/90°	X	X
<i>IQT Pro</i>	IQT1000, IQT2000	86 turns/90°	X	X

During electric operation of the actuator, the handwheel is mechanically disengaged from the drive. To engage handwheel operation, the hand/auto selection lever is pushed down and released after which handwheel operation remains selected. When electrical operation takes place the actuator will automatically return to motor drive without lever or handwheel kickback.

The hand/auto selection lever incorporates a facility for locking in the hand or auto positions using a 6 mm diameter hasp padlock (not supplied by Rotork), preventing engagement of motor drive (locked in hand) or engagement of handwheel drive (locked in auto). Emergency disengagement of motor drive can be selected by pushing down and holding the hand/auto lever during electric operation.



Standard specifications

10.2 Lubrication

IQ and IQT actuators are factory filled for life with premium quality gear oil selected for the application. Standard oils are automotive grades easily available worldwide and have been used successfully for over 40 years. Oil lubrication outperforms grease over a wide temperature range and allows installation in any orientation. It has none of the problems

associated with grease such as separation at elevated temperatures and “tunnelling” at lower temperatures where grease is thrown away from rotating components creating a void or tunnel in the grease around components that require lubrication.

Lubrication

Range	Standard oil	Standard temp range	Option Low temp -50°C to +40°C (-58°F to +104°F)
IQ Pro	SAE80EP	-30 to +70 °C (-22 to +158 °F)	MOBIL SHC624
IQT Pro	TEXACO 9330 +25% Kerosene	-30 to +70 °C (-22 to +158 °F)	TEXACO 9330 +75% BP SHF LT15

Food grade

Lubricant is a synthetic, non-aromatic hydrocarbon mixture with PTFE and other additives. It does not contain chlorinated solvents. Food grade grease used in assembly and thrust bearings is Hydra Lube WIG Medium-NLGI-123.

10.3 Finish

All IQ and IQT *Pro* actuator finishes are tested in accordance with Rotork 1,000 hour cyclic salt spray test procedure which is the most realistic and arduous test cycle applicable. The test combines cyclic salt spray, drying and humidity at elevated temperatures on complete factory built actuators. This tests the finish and the various substrate materials, fixings and

interfaces that make up an actuator. Substrate materials and finishes are selected to provide maximum corrosion resistance combined with good adhesion. For full specification of paint finishes refer to publication PUB000-046.

Ranges	Corrosivity category	Exterior environment	Interior environment
IQ10 to IQ95 and IQT125 to IQT2000	C1	N/A	Heated buildings with clean atmospheres e.g. offices, shops, schools and hotels.
	C2	Atmospheres with low levels of pollution, e.g. rural areas.	Unheated buildings where condensation may occur, e.g. depots and sports halls.
	C3	Urban and industrial atmospheres, moderate SO ₂ pollution, e.g. city centres and coastal areas with low salinity.	Production rooms with high humidity and some air pollution, e.g. food processing plants, laundries, breweries and dairies.
IQ10 to IQ35 and IQT125 to IQT2000	C4	Industrial and coastal areas with moderate salinity, e.g. coastal ships and boatyards.	Areas with permanently aggressive atmospheres, e.g. chemical plants and swimming pools.
	C5-M (Marine)	Coastal and offshore areas with high salinity, e.g. offshore rigs and boats.	Areas with extremely aggressive atmospheres containing high humidity, salinity and pollutant concentration, e.g. cooling towers and boats.

Project specific finishes / colours can be catered for. Apply to Rotork.

Standard specifications

10.4 Motor

IQ and IQT *Pro* actuators utilise purpose designed motors integral to the actuator. As such, motors do not fall within the scope of IEC 60034- MG1, however they do meet the applicable requirements, where pertinent, to motor design for actuator operation.

Actuator type	Duty classification	Comments
IQ	On-Off & inching	Class F insulated, 3-phase squirrel cage motor incorporating thermostat protection. Low inertia design. Nominal 60 Starts per hour at a rate not exceeding 200 starts per hour, 15 minutes rated based on a nominal torque of 33% of rated. Class H available as an option where hazardous area certification does not limit temperature rise to "T4" 135 °C.
IQM	Modulating	Class F insulated, 3-phase squirrel cage motor incorporating thermostat protection. User selectable thyristor controlled dynamic braking available. Low inertia design. 1,200 starts per hour, 50% duty cycled based on a modulating torque of 50% of rated torque. Class H available as an option where hazardous area certification does not limit temperature rise to "T4" 135 °C.
IQT	On-Off & inching	Permanent magnet 24 VDC motor (DC supply derived internally from 3 and single phase supplies) incorporating thermostat protection. Low inertia design. Nominal 60 Starts at a rate not exceeding 200 starts per hour, 15 minutes rated based on a nominal torque of 75% of rated.
IQTM	Modulating	Permanent magnet 24 VDC motor (DC supply derived internally from 3 and single phase supplies) incorporating thermostat protection. Low inertia design. Nominal 1,200 starts per hour, 50% duty cycled based on a modulating torque of 50% of rated torque.

Reference documents

IQ Motor data publication PUB002-018

IQM Motor data publication PUB002-032

IQT / IQTM Motor data publication PUB002-022

Standard specifications

10.5 Power module

The power module for IQ and IQT *Pro* actuators produces internal power supplies for control systems and remote control derived from the actuator electrical supply. It also contains the motor control and switching components.

Actuator type	Internal power supplies	Motor switching
IQ	Split bobbin transformer producing control circuits, option card supplies and supply for 24 VDC actuator fed remote control (120 VAC option).	Reversing contactor assembly, mechanically and electrically interlocked. 24 VDC coil up to and including size IQ35 and 120 VAC for IQ40 and above.
IQM	Split bobbin transformer producing control circuits, option card supplies and supply for 24 VDC actuator fed remote control. Fuse protected.	Solid state thyristor array for motor switching / reversal and braking (user selectable). Includes snubber protection and timing control.
IQT / IQTM	Split bobbin transformer producing control circuits, option card supplies and supply for 24 VDC actuator fed remote control (120 VAC option). Fuse protected.	Toroidal power transformer / rectifier deriving DC motor power supply from AC actuator supply - fuse protected. Solid state motor switching incorporating motor speed control.

10.6 Torque sensor

State of the art piezo thrust sensor measures motor shaft thrust produced as a reaction to output torque developed in the motor worm and wheel gear assembly. Thrust measured is directly proportional to output torque. The piezo sensor develops a voltage proportional to shaft thrust (output torque) which is amplified and then measured by the control module. Output torque is controlled by switching the motor off when the set torque limits have been reached. This system allows the torque to be displayed via the LCD display and captured by the data logger in the form of valve torque profiles, statistical torque information and the event log.

10.7 Position sensor

Contact-less hall effect sensors measure actuator output shaft angular rotation to a resolution of 7.5° (15° max for reversal). Sensors are direction sensitive producing a phased digital pulse width modulated signal. The control module counts the pulses and compares these to the set limit range. Precise position control is then available for limit switching, position indication and data logging. The position sensor is very simple with only one moving component and has a proven, reliable track record in use with IQ actuators.

Standard specifications

10.8 Control module

The control module for IQ and IQT *Pro* actuators is common and takes the form of a PCB with on-board liquid crystal displays (LCD). For IQM and IQTM actuators the control module incorporates “fast remote” control components (24 VDC remote control only) allowing rapid actuator switching down to 20 ms pulses for precise positioning.

Logic controlled, the control module is programmed over the non-intrusive infrared interface with set-up configuration for torque, limits indication and control features undertaken using the supplied setting tool. It monitors local and remote control signals, torque and position to switch the actuator motor in the correct direction or off.

Standard control features are shown below:

Feature	Type	Specification
Remote control	Input	User switched Open/Close/Stop/ESD and interlock signals. Opto-isolated inputs for protection.
Local control	Input	Open/Close/Stop and Local/Remote selection. Non-intrusive control switches are magnetically operated so there is no penetration of covers.
Position - IQ <i>Pro</i>	Input	Digital signal derived by position sensor. Resolution to 7.5° of output rotation. Limit range configurable between 2.5 and 100,000 output turns.
Position - IQT <i>Pro</i>	Input	Digital signal derived by position sensor. Angular resolution to 0.1° Minimum Limit setting range is 10°. Maximum range will be limited by mechanical stops (nominally 95°). Position sensing is battery backed up for operation when the main electrical supply to the actuator is switched off. Power off local and remote (contacts S1 – S4) position indication and updating is enabled using a standard battery located in a separate compartment.
Torque - IQ <i>Pro</i>	Input	The piezo thrust sensor directly measures output torque and converts value to a voltage signal. Torque can be set in the range 40% to 100% of rated torque with the additional facility to bypass torque switching.
Torque - IQT <i>Pro</i>	Input	Torque signal derived from DC motor current which is directly proportional to torque. Torque can be set in the range 40% to 100% of rated torque with the additional facility to bypass torque switching.
Set-up	Input	Set-up over the Infra red interface allows all settings to be configured for valve and process requirements. Set-up is non-intrusive requiring no covers be removed using the supplied setting tool. All settings can be password protected.
Indication contacts	Output	Four volt free contacts S1 to S4 can be configured for a variety of position, status and alarm indication for remote indication and monitoring.
LCD indication	Output	The on board backlit LCD display presents position, torque and set up displays for configuration. The LCD display is divided into 2 parts providing a large position indication (Open/Close icons plus % readout in 1% increments for mid travel) and a multilingual text display providing status, alarm and set up information.
Data logger	Output	The control module includes a data logger which stores torque, position and operational data in non volatile memory for download via IrDA™ to the supplied setting tool or notebook PC. Data is date/time stamped. Data logger can be analysed using freeware IQ Insight for PC.
Memory	System	All configured settings are stored in non volatile EEPROM memory (does not require power).
Micro-controller	System	Provides all control function logic, set up programming and allied system requirements. Software is field upgradeable for future enhancements. The micro-controller is widely used in the automotive industry with a long track record and a very reliable history.

Standard specifications

10.9 Conduit / cable entries

IQ and IQT *Pro* gearcases are machined with conduit/cable entries as indicated below. Unless otherwise specified IQ *Pro* range actuators are despatched with adapter 1 fitted into the gearcase entry. Unless otherwise specified IQT *Pro* range

actuators are despatched with no adapters fitted. Alternative adapters are available. Number of entries required and adapter type must be specified with order.

Actuator type	Gearcase entries	Adapter 1
IQ <i>Pro</i>	1 x M40 plus 2 x M25	1 x ASA 1.0 plus 2 x ASA 0.75
IQ <i>Pro</i> option	Additional 1 x M25	Additional 1 x ASA 0.75
IQT <i>Pro</i>	2 x M25	2 x ASA 0.75
IQT <i>Pro</i> option*	Additional 2 x M25	Additional 2 x ASA 0.75

IQ *Pro* and IQT *Pro* actuators are despatched with transit plugs fitted into the conduit entries. It is the responsibility of the installer to ensure the appropriate cable/conduit adapters, cable glands and/or blanking plugs are fitted in order to maintain hazardous area certification and ingress protection levels. Certified adapters and blanking plugs are available as optional extras.

* IQT *Pro* actuators supplied with Pakscan, Profibus, Modbus or interface option cards will be supplied with the optional entries provided (4 entries in total).

10.10 Terminals

The terminal compartment for IQ and IQT *Pro* actuators takes the form of a separately sealed compartment containing segregated metric thread M5 power and M4 control terminals. Terminal screws and washers are supplied with the actuator. Terminals are designed to accept ring tag crimped field wiring conductors up to 16 mm² for power and 4 mm² for control/indication. The terminal compartment cover carries a terminal identification code card. Each actuator is despatched with the applicable Installation and Maintenance Manual, actuator wiring diagram and remote control connection schematic.

10.11 Wiring

IQ and IQT *Pro* actuators utilise jig built wiring harnesses of individually numbered, tropical grade PVC insulated, stranded conductors. All internal control connections to the printed circuit boards use unique or polarised plugs and sockets.

10.12 Battery

When power to the actuator is isolated, all settings are retained in an EEPROM. In the event of manual operation of the valve during isolation or loss of the power supply a battery provides power to the position-sensor and control module to update the valve position. The battery also powers the LCD display, without backlighting, and the four latching contacts S1-S4 while the power to the actuator is not available. Infrared set up is also available with main power off.

Based on experience gained of typical applications, the expected battery life is around 5 years. Battery life is however subject to temperature and at elevated temperatures may be reduced. Actuators can operate perfectly well without a battery, however if operated by handwheel without power the control module cannot update with the new position when power is restored. Limits should therefore be reset.

Rotork Site Services

Rotork understands the value of prompt, punctual and superior site services. Rotork Site Services have specialist expertise, insight and experience in service support for mission-critical flow control and instrumentation solutions for oil and gas, water and wastewater, power, chemical process and industrial applications. We offer global frontline support backed by dedicated in-house experts.

Our service solutions increase plant efficiency and reduce maintenance costs, while workshop services return equipment to as-new condition. Our experience and understanding of the flow control industry means we have extensive insight and ideas of what we can do to provide significant value to our customers and their operations.

Rotork Site Services is comprised of two main areas; Lifetime Management and Site Services. Lifetime Management is the suite of services within Rotork Site Services which help you manage the risk associated with aging assets and includes our Reliability Services offering. Site Services comprises essential actuator service, repair, maintenance and upgrades.

Rotork has specialist expertise, insight and experience in flow control.

We provide insight into how we can deliver value to our customers.

Our service solutions increase plant efficiency and reduce maintenance costs.



Rotork Site Services

Lifetime Management

The services available within Lifetime Management offer a complete solution to managing the risks associated with the life cycle of your equipment and their obsolescence (which compromise reliable performance and valuable uptime).

The aim of Lifetime Management is to provide you with constant support and minimum- to- no disruption to your production flow. It is a customisable service, offering designed to seamlessly maintain and improve your assets. We manage the inherent risks associated with advances in technology, component obsolescence and ageing equipment for you. We are committed to helping customers maximise the continuous, fault-free operation and working life of their actuators. Supporting the continuous and reliable operation of your plant allows for improved performance and increases in valuable uptime.

Lifetime Management covers:

- Reliability Services
 - Basic - health check
 - Standard - planned maintenance
 - Premium - enhanced maintenance
- Upgrade services (retrofit)
- Planned shutdown support
- Life cycle services
- Overhauls/refurbishment
- Customised spares programme
- Intelligent Asset Management (iAM) reporting

Site Services

Site Services provides the essential on-site actuator service, repair, maintenance and upgrades as part of our service offering, plus the commissioning of new actuators and applications. It includes off-site work completed at a Rotork support centre including recertification, automation, testing and product selection.

Our decades of experience in the industrial actuation and flow control markets means that customers can rely on us to understand their problems and to deliver reliable, economic solutions. Rotork's talented and experienced engineers have an in-depth understanding of the problems that are faced in the field and they know how to fix them.

On sites where providing evidence of valid asset certification is a legal requirement, Rotork engineers can carry out the necessary OEM level inspections and provide the statutory paperwork to comply with regulations.

- Field support
- Planned shutdown support
- Actuator workshop overhaul
- Valve automation services
 - On-site
 - Off-site
- Global support



rotork®



www.rotork.com

A full listing of our worldwide sales and service network is available on our website.

Rotork plc
Brassmill Lane, Bath, UK
tel +44 (0)1225 733200
email mail@rotork.com

PUB002-214-00
Issue 02/25

As part of a process of on-going product development, Rotork reserves the right to amend and change specifications without prior notice. Published data may be subject to change. For the very latest version release, visit our website at www.rotork.com

The name Rotork is a registered trademark. Rotork recognises all registered trademarks. The Bluetooth® word mark and logos are registered trademarks owned by Bluetooth SIG, Inc. and any use of such marks by Rotork is under license. Published and produced in the UK by Rotork. POLTG0225